

Shenzhen Getian Opto-Electronics Co.,Ltd

## SPECIFICATION FOR APPROVAL

<b>Customer Name</b>	
<b>Product Name</b>	Through Hole-LED
<b>Model No.</b>	IE-P03THRB470
<b>Description</b>	3mm Blue LED
<b>Date</b>	2007/9/1
<b>Sample No.</b>	

Clients (Signature) :                      DD    MM    YYYY

# SPECIFICATION FOR APPROVAL

## Package Dimensions

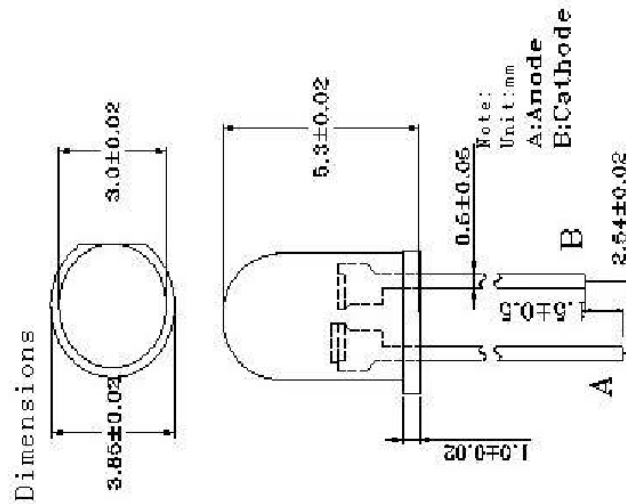

### Notes

1. All dimensions are in millimeters (inches).
2. Tolerance is  $\pm 0.25\text{mm}$  ( $0.010''$ ) unless otherwise noted.
3. Protruded resin under flange is  $1.0\text{mm}$  ( $0.04''$ ) max.
4. Lead spacing is measured where the leads emerge from the package.
5. Specifications are subject to change without notice.

## Spatial Distribution

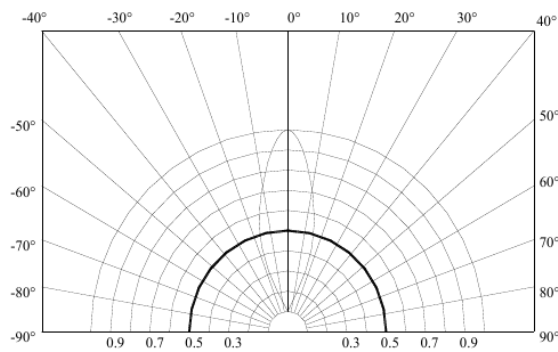

PART NUMBER	REV	PAGE	DATE
IE-P03THRB470	R101	1/3	2007-09-01

## SPECIFICATION FOR APPROVAL

### Electrical / Optical Characteristics at TA=25°C

Parameter	Symbol	Min.	Typ.	Max.	Unit	Test Condition
Luminous Intensity	<b>LM</b>	1500		2500	mcd	IF = 20mA
Viewing Angle	<b>2 θ 1/2</b>	30		45	deg	IF = 20mA
Dominant Wavelength	<b>Tc</b>	465	470	475	nm	IF = 20mA
Spectral Line Half-Width	$\Delta \lambda$				nm	IF = 20mA
Forward Voltage	<b>VF</b>	3.0	3.2	3.5	V	IF = 20mA
Reverse Current	<b>IR</b>			20	μ A	VR = 5V

### Absolute Maximum Ratings at TA=25°C

Parameter	Maximum Rating
Power Dissipation	0.06W
Peak Forward Current (1/10 Duty Cycle, 0.1ms Pulse Width)	60mA
Continuous Forward Current	20mA
Derating Linear From 30°C	0.5mA/°C
Reverse Voltage	5V
Operating Temperature Range	-20°C to + 80°C
Storage Temperature Range	-30°C to + 100°C
Lead Soldering Temperature [1.6mm(.063") From Body]	260°C for 5 Seconds

PART NUMBER	REV	PAGE	DATE
<b>IE-P03THRB470</b>	R101	2/3	2007-09-01

# SPECIFICATION FOR APPROVAL

## Typical Electro-Optical Characteristics Curves

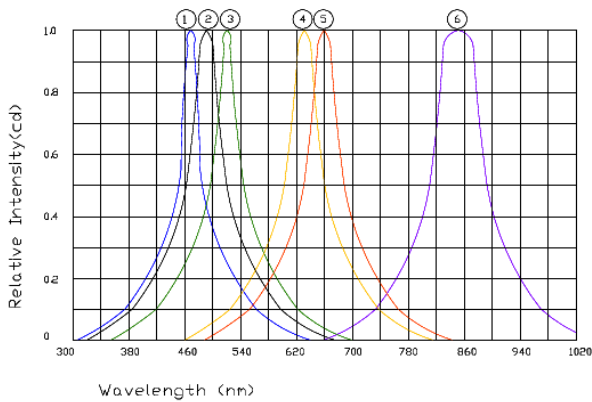
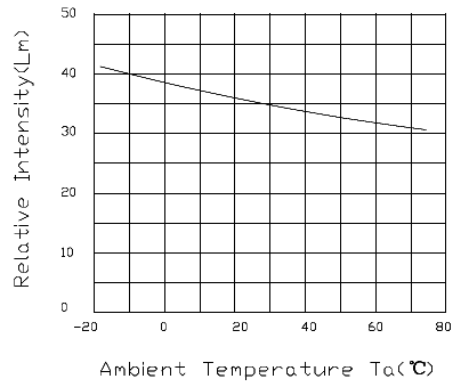
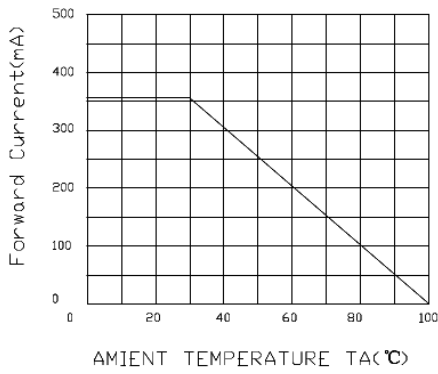
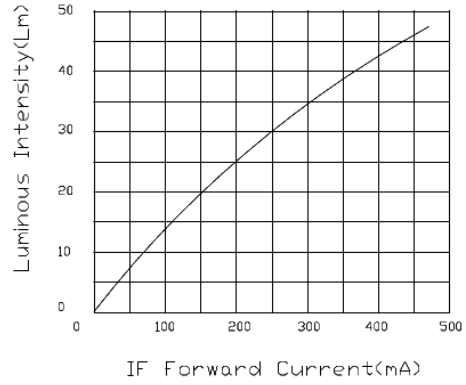
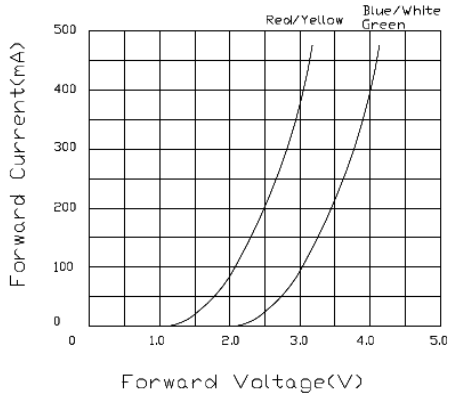

- ① Blue Lamp(InGaN)
- ② White Lamp(InGaN)
- ③ Pure Green Lamp(InGaN)
- ④ Yellow Green Lamp(AlInGaP)
- ⑤ Red Lamp(AlInGaP)
- ⑥ Infrared Lamp(850nm)

PART NUMBER	REV	PAGE	DATE
IE-P03THRB470	R101	3/3	2007-09-01