



佛山市国星光电股份有限公司
FOSHAN NATIONSTAR OPTOELECTRONICS CO., LTD

产品规格书

SPECIFICATION

顾客名称 Customer		产品名称 Product	POWER LED
顾客型号 Customer Type		产品型号 Type	FP-3535UV-BC-AXS
顾客部品号 Customer No.		版本号 Version NO	A0 版



地址: 广东省佛山市禅城区华宝南路 18 号
Add: NO.18 South Huabao Rd, Foshan, Guangdong, China
电话 (Tel): 0086-0757-82100238
传真 (Fax): 0086-0757-82109311
邮编 (Zip): 528000
<http://www.nationstar.com>

研发中心 Research & Development Center		客户 (加盖公章) Customer (Stamp)	
制定 DRAW	审核 CHECK	批准 APPROVE	确认 CONFIRM
发放日期 (Release Date): 2017-12-29			

HIGHT POWER Light Emitting Diode

技术数据表 Technical Data Sheet

本产品主要作为信号指示及照明的电子元件广泛应用于各类使用表面贴装结构的电子产品中。本产品主要作为工业紫外固化和一般的紫外应用，如诱虫、辨伪、美甲等。

This product is generally used as indicator and luminary for electronic equipment. And it This product is mainly used as industrial UV curing and general UV applications, such as mothkilling, discrimination, Manicure etc.

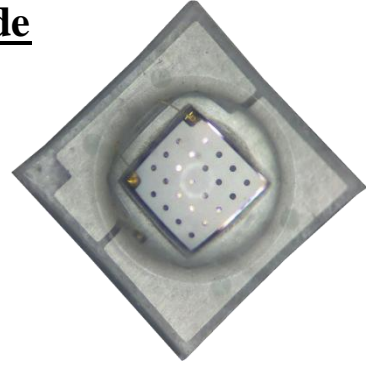

特性:

Features:

- 管芯材料: InGaN
Material: InGaN
 - 封装材料: 硅胶
Encapsulation: Silicone
 - 焊接方法: 无铅回流焊
Soldering methods: Pb-Free reflow soldering
 - 光强高, 功耗低, 可靠性好, 寿命长
High Luminous Intensity ,Low Power Dissipation, good Reliability and Long Life
 - 符合欧盟公布的 ROHS 指令要求
Complied With ROHS Directive
- 发光波长: 365-405nm
Emitting Wavelength: 365-405nm

目录

Catalogue

参数	3
Electrical Characteristics	3
典型特性曲线.....	6
Typical Characteristics Curves.....	6
可靠性试验.....	7
Reliability Test Items And Conditions.....	7
外形尺寸	8
Outline Dimension	8
包装.....	9
Packaging.....	9
焊接指导	11
Guideline for Soldering	11
使用注意事项.....	13
Precautions	13
附录: 分档标准、色度坐标图.....	16
Appendix: Grading Standard and Chromaticity Diagram.....	16

* 产品规格如因工艺改进而有所改变, 恕不另行通知。

*The Specifications of the product may be modified for improvement without notice.

电性参数

Electrical Characteristics

极限参数(T_a=25℃) Absolute Maximum Ratings (Temperature=25℃):

参数名称 Parameter	符号 Symbol	数值 Rating	单位 Unit
正向电流 Forward Current	IF	1000 (380-410nm) 700 (360-380nm)	mA
正向脉冲电流*Pulse Forward Current*	IFP	1250	mA
反向电压 Reverse Voltage	VR	5	V
功耗 Power Dissipation	Pd	3600	mW
工作温度 Operating Temperature	Topr	-30 ~ +105	℃
储存温度 Storage Temperature	Tstg	-40 ~ +100	℃
热阻 (结到焊点) Thermal resistance	RthJ-S	12	℃/W
结温 Junction Temperature	Tj	125	℃
焊接温度 Welding temperature	Tsol	回流焊 Reflow soldering : 260 ℃ for 10 sec.	
抗静电能力 Antistatic ability	ESD	>1000	V

* 注: 脉冲宽度≤0.1ms, 占空比≤1/10

* Note: Pulse width≤0.1ms, Duty≤1/10

光电参数 (Ta=25℃) Electro-Optical Characteristics (Temperature=25℃):

产品型号 Product model	参数名称 Parameter	符号 Symbol	条件 Condition	最小 值 Min.	典型 值 Typ.	最大 值 Max.	单 位 Unit
FP-3535UV-BC-A17S FP-3535UV-BC-A18S	反向电流 Reverse Current	I_R	$V_R=5$			10	μA
	正向电压 Forward Voltage	V_F	$I_F=350mA$		3.3		V
	光功率 Radiometric	Φ_e	$I_F=350mA$		700		mW
			$I_F=500mA$		950		
			$I_F=700mA$		1300		
		$I_F=1000mA$		1750			
	峰值波长 Peak wavelength	λ_p		400	405	410	nm
FP-3535UV-BC-A15S FP-3535UV-BC-A16S	反向电流 Reverse Current	I_R	$V_R=5$			10	μA
	正向电压 Forward Voltage	V_F	$I_F=350mA$		3.3		V
	光功率 Radiometric	Φ_e	$I_F=350mA$		700		mW
			$I_F=500mA$		950		
			$I_F=700mA$		1300		
		$I_F=1000mA$		1750			
	峰值波长 Peak wavelength	λ_p		390	395	400	nm
FP-3535UV-BC-A13S FP-3535UV-BC-A14S	反向电流 Reverse Current	I_R	$V_R=5$			10	μA
	正向电压 Forward Voltage	V_F	$I_F=350mA$		3.4		V
	光功率 Radiometric	Φ_e	$I_F=350mA$		620		mW
			$I_F=500mA$		850		
			$I_F=700mA$		1100		
		$I_F=1000mA$		1550			
	峰值波长 Peak wavelength	λ_p		380	385	390	nm

产品型号 Product model	参数名称 Parameter	符号 Symbol	条件 Condition	最小 值 Min.	典型 值 Typ.	最大 值 Max.	单 位 Unit
FP-3535UV-BC-A11S FP-3535UV-BC-A12S	反向电流 Reverse Current	I_R	$V_R=5$			10	μA
	正向电压 Forward Voltage	VF	IF=350mA		3.5		V
	光功率 Radiometric	Φ_e		IF=350mA	550		mW
				IF=500mA	780		
				IF=700mA	1000		
峰值波长 Peak wavelength	λ_p		370	375	380	nm	
FP-3535UV-BC-A9S FP-3535UV-BC-A10S	反向电流 Reverse Current	I_R	$V_R=5$			10	μA
	正向电压 Forward Voltage	VF	IF=350mA		3.6		V
	光功率 Radiometric	Φ_e		IF=350mA	500		mW
				IF=500mA	680		
				IF=700mA	950		
峰值波长 Peak wavelength	λ_p		360	365	370	nm	

典型特性曲线

Typical Characteristics Curves

伏安特性

Volt-Ampere Characteristics

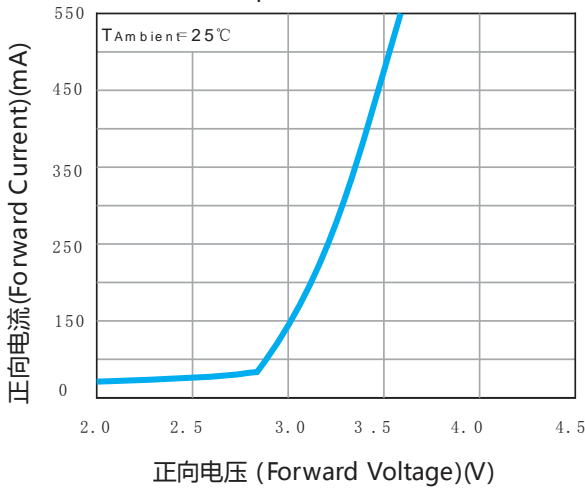

相对光强与正向电流特性

Relative Luminous Intensity VS Forward Current

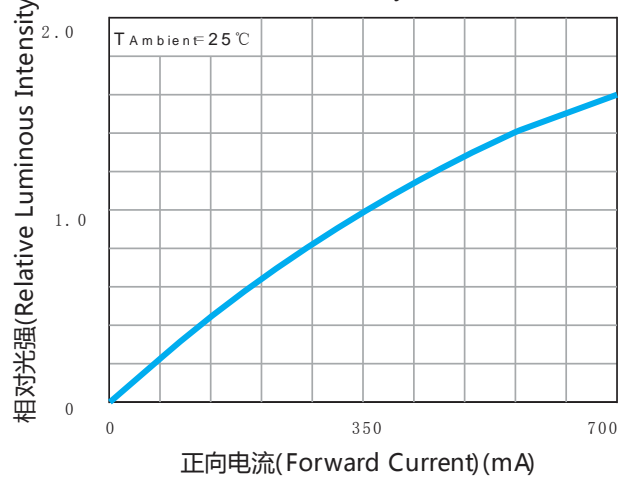

正向电流降额曲线
Forward Current Derating Curve

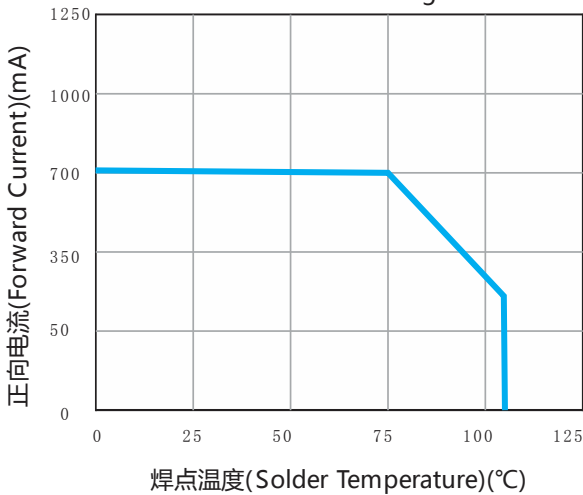

光强与环境温度曲线

Luminous Intensity VS Ambient Temperature

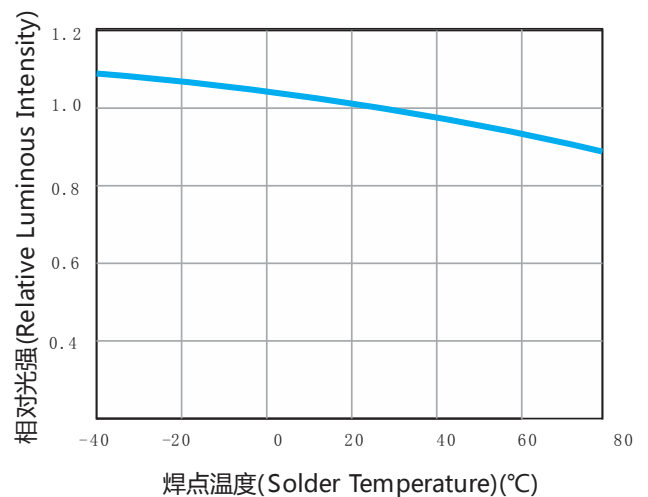

光谱分布特性曲线
Relative Spectral Distribution

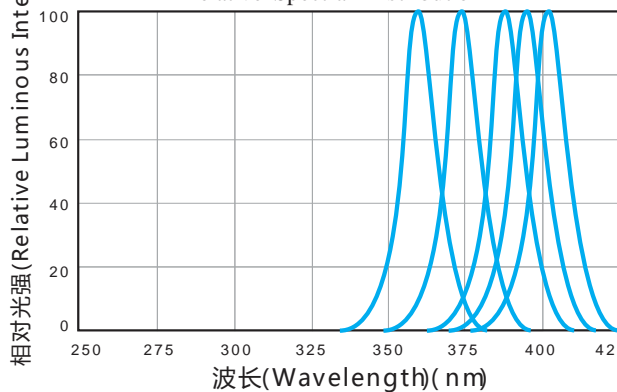

光强分布特性曲线
Typical Spatial Distribution

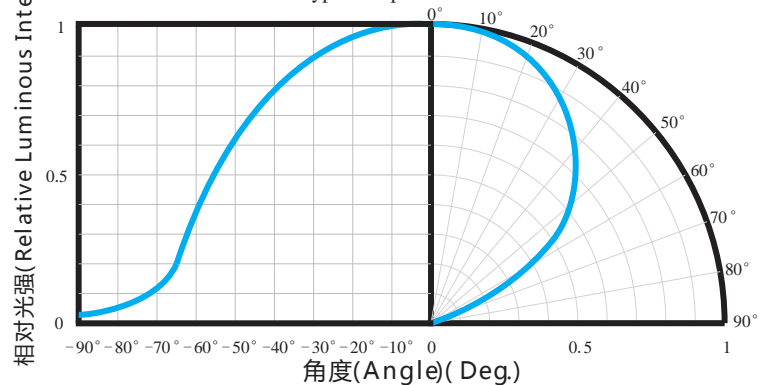

可靠性试验

Reliability Test Items And Conditions

实验项目 Test Items	参考标准 Reference	实验条件 Test Conditions	时间 Time	样品数 Quantity	判据 Criterion
冷热冲击 Thermal Shock	MIL-STD-202G	-40(30min)←→ 100°C(30min)	100 cycles	22	22/22
湿热循环 Temperature And Humidity Cyclic	JEITA ED-4701 200 203	-10°C ~ 65°C, 0% ~ 90%RH 24hrs	10 cycles	22	22/22
高温储存 High Temperature Storage	JEITA ED-4701 100 103	Ta=100°C	1000h	22	22/22
低温储存 Low Temperature Storage	JEITA ED-4701 200 202	Ta=-40°C	1000h	22	22/22
高温高湿储存 High Temperature High Humidity Storage	JEITA ED-4701 100 103	Ta=60°C, RH=90%	1000h	22	22/22
常温寿命试验 Life Test	JESD22-A108D	Ta=25°C, IF =700mA (360-380nm) IF =1000mA (380-410nm)	1000h	10	22/22
耐焊接热 Resistance to Soldering Heat	JEITA ED-4701 300 301	Tsol*=260°C, 10secs	3 times	22	22/22

失效判断标准 Criteria For Judging Damage:

测试项目 Test Items	符号 Symbol	测试条件 Test Conditions	判定标准 Criteria For Judging Damage
正向电压 Forward Voltage	V _F	I _F = I _{FT}	初始值±10% Initial Data±10%
反向电流 Reverse Current	I _R	V _R = 5V	I _R ≤ 10μA
光功率 Radiometric	Φ _e	I _F = I _{FT}	平均 Φ _e 衰减 ≤ 30%, 单个 Φ _e 衰减 ≤ 50% Average Φ _e degradation ≤ 30%; Single LED Φ _e degradation ≤ 50%
耐焊接热 Resistance to Soldering Heat			材料无内部裂痕、无材料间爆裂、剥离、无死灯。 Material without internal cracks, no material between stripped, no deaded light.

* 注: T_{sol}-锡液温度 * Note: T_{sol}-Temperature of tin liquid.

外形尺寸

Outline Dimension

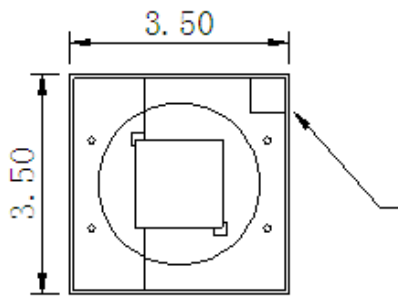

此处方块表示负极
Squares Represent The Cathode

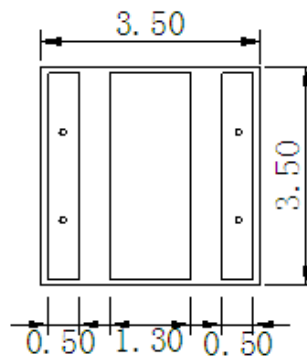
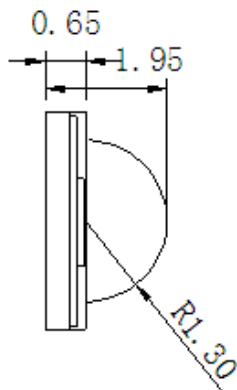

极性 Polarity

- ① 正极
- ② 负极

Note:

A : 缺口标志

A : Nick Mark

单位 : mm , 未注公差 : ± 0.1 mm

All dimensions in mm.

Tolerances unless mentioned is ± 0.1 mm.

包装

Packaging

(1)载带 Carrier Tape

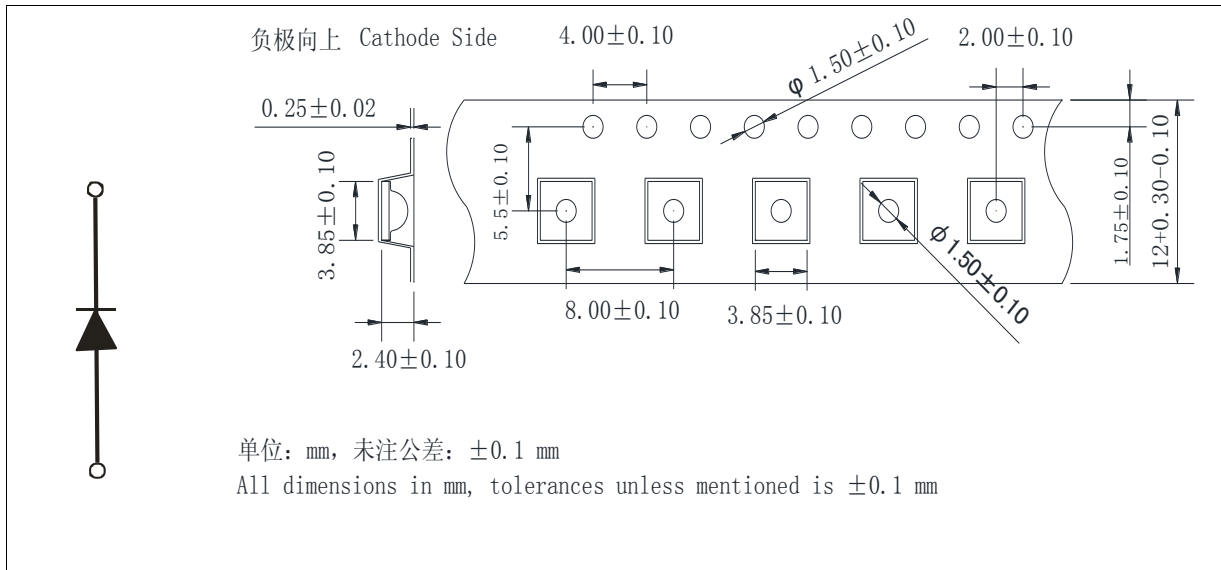

(2)编带细节 Details Of Carrier Tape

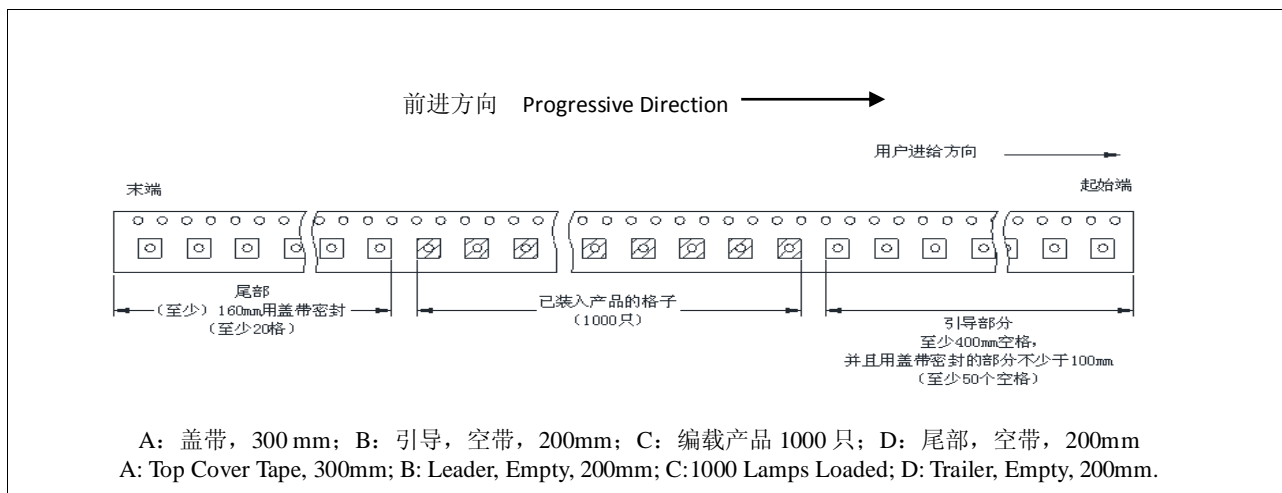

(3)带盘 Reel Dimension

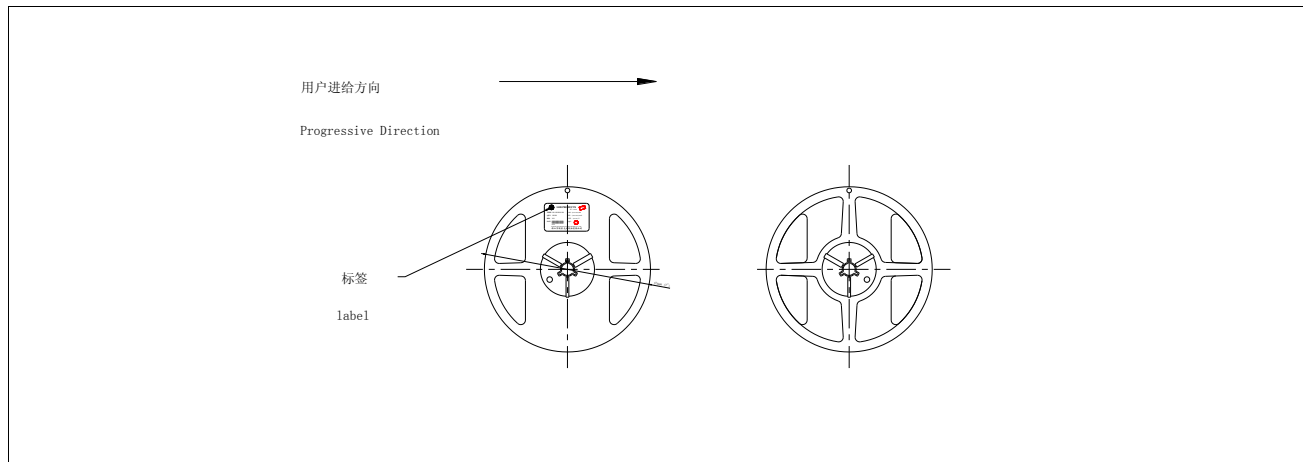

(4)防潮抗静电包装 Moisture Proof and Anti-Electrostatic Foil Bag

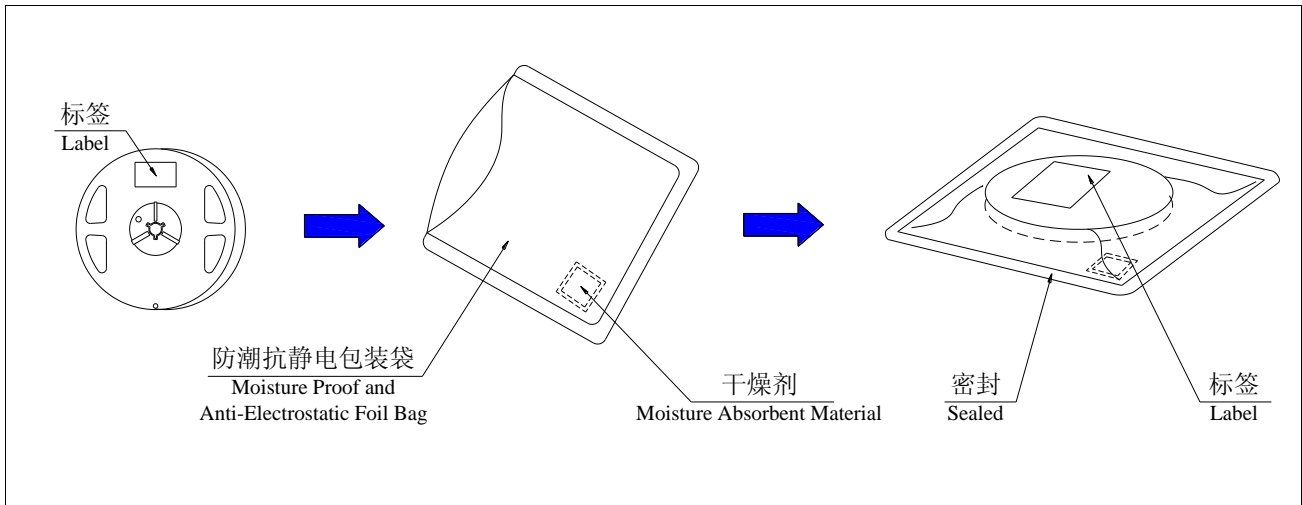

(5)外包装箱 Cardboard Box

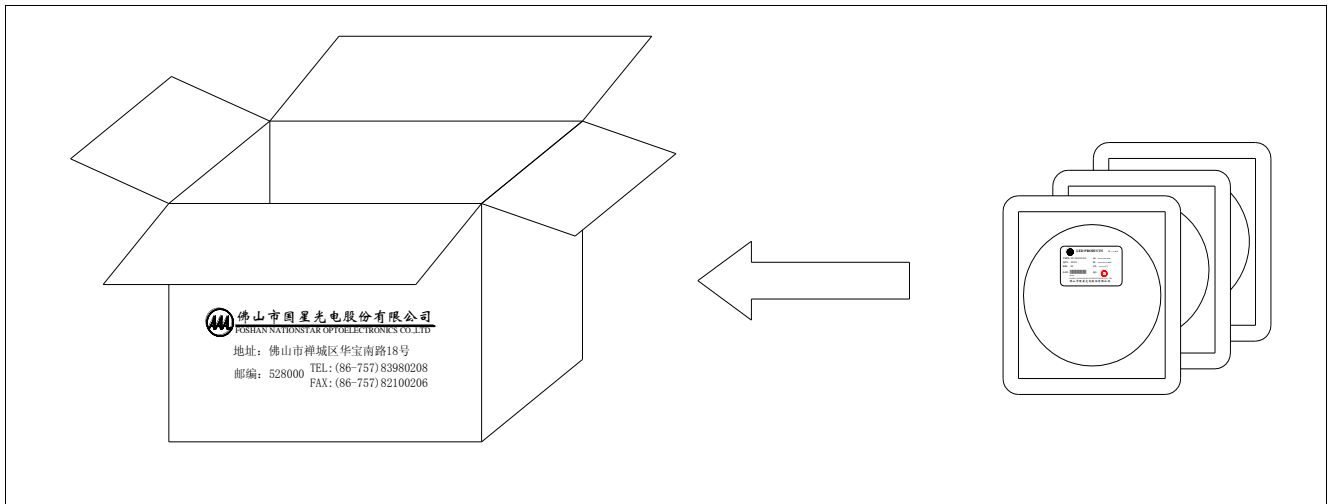

(6)标签说明 Label Explanation

TYPE : 产品型号 Product model
 QTY : 数量 Quantity
 BIN : 分档 Rank
 SC : 生产编码 Production code
 LOT : 批号 Lot Number
 Φ (mW): 光功率范围 Radiometric Range
 VF : 正向电压范围 Forward Voltage
 IF : 测试电流 Test Current
 λ_p : 峰值波长 Peak wavelength

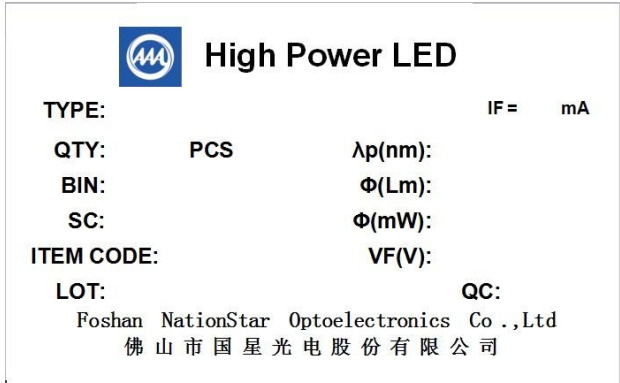

High Power LED

TYPE: _____ IF = _____ mA

QTY: _____ PCS λ_p (nm): _____

BIN: _____ Φ (Lm): _____

SC: _____ Φ (mW): _____

ITEM CODE: _____ VF(V): _____

LOT: _____ QC: _____

Foshan NationStar Optoelectronics Co.,Ltd
佛山市国星光电股份有限公司

焊接指导

Guideline for Soldering

1. 使用烙铁人手焊接

Hand Soldering

推荐使用功率低于 20W 的烙铁，焊接时烙铁的温度必须保持在 360°C 以下，且每个电极只能进行一次焊接，每次焊接的持续时间不得超过 3 秒。

人手焊接过程中的不慎操作易引起 LED 产品的损坏，应当小心谨慎。

A soldering iron of less than 20W is recommended to be used in Hand Soldering. Please keep the temperature of the soldering iron under 360°C while soldering. Each terminal of the LED is to go for less than 3 second and for one time only.

Be careful because the damage of the product is often started at the time of the hand soldering.

2. 回流焊接：推荐使用以下无铅回流焊接温度图进行。

Reflow Soldering: Use the conditions shown in the under Figure of Pb-Free Reflow Soldering.

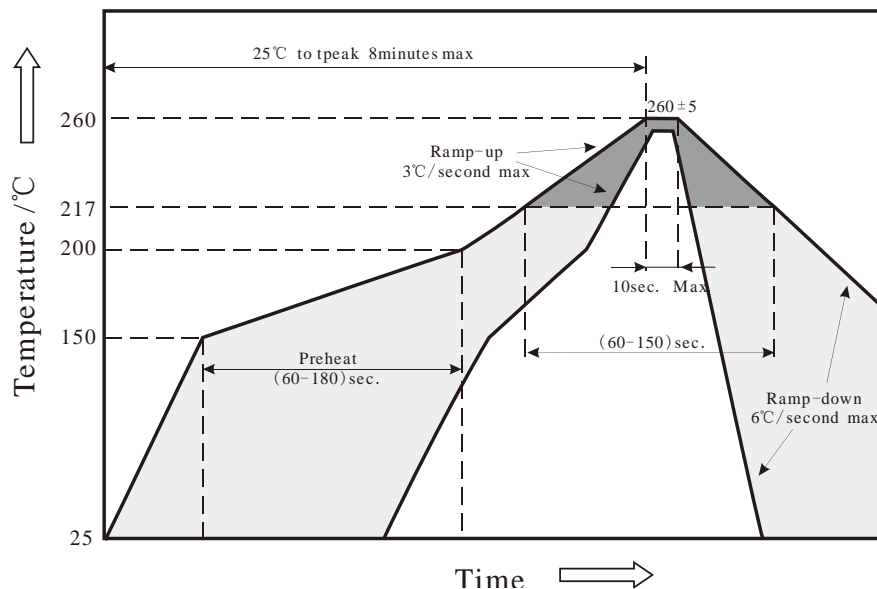

- 回流焊接最多只能进行两次。

Reflow soldering should not be done more than two times.

- 在回流焊接升温过程中，请不要对 LED 施加任何压力。

Stress on the LEDs should be avoided during heating in soldering process.

- 在焊接完成后，待产品温度下降到室温之后，再进行其他处理。

After soldering, do not deal with the product before its temperature drop down to room temperature.

3. 清洗:

Cleaning

在焊接后推荐使用酒精进行清洗，在温度不高于 30℃ 的条件下持续 3 分钟，不高于 50℃ 的条件下持续 30 秒。使用其他类似溶剂清洗前，请先确认使用的溶剂不会对 LED 的封装和环氧树脂部分造成损伤。

超声波清洗也是有效的方法，一般最大功率不应超过 300W，否则可能对 LED 造成损伤。请根据具体的情况预先测试清洗条件是否会对 LED 造成损伤。

It is recommended that alcohol be used as a solvent for cleaning after soldering. Cleaning is to go under 30°C for 3 minutes or 50°C for 30 seconds. When using other solvents, it should be confirmed beforehand whether the solvents will dissolve the package and the resin or not.

Ultrasonic cleaning is also an effective way for cleaning. But the influence of Ultrasonic cleaning on LED depends on factors such as ultrasonic power. Generally, the ultrasonic power should not be higher than 300W. Before cleaning, a pre-test should be done to confirm whether any damage to LEDs will occur.

*** 注意:** 此一般指导原则并不适用于所有 PCB 设计和焊接设备的配置。具体工艺受到诸多因素的影响，请根据特定的PCB设计和焊接设备来确定焊接方案。

*** Note:** This general guideline may not apply to all PCB designs and configurations of all soldering equipment. The technique in practice is influenced by many factor, it should be specialized base on the PCB designs and configurations of the soldering equipment.

使用注意事项

Precautions

1. 贮存:

Storage

- 本产品使用密封防潮抗静电袋包装，并附有干燥剂，未开封的产品有一年的保存时间。

Moisture proof and anti-electrostatic package with moisture absorbent material is used, to keep moisture to a minimum.

- 开封前，产品须存放在温度不高于 30℃，湿度不高于 60%RH 的环境中。

Before opening the package, the product should be kept at 30℃ or less and humidity less than 60% RH, and be used within a year.

- 开封后，产品须存放在温度不高于 30℃，湿度不高于 10%RH 的环境中，且应该在 24 小时（1 天）内使用完。建议工作环境为温度不高于 30℃，湿度不高于 60%RH。

After opening the package, the product should be stored at 30℃ or less and humidity less than 10%RH, and be soldered within 24 hours (1 day). It is recommended that the product be operated at the workshop condition of 30℃ or less and humidity less than 60%RH.

- 对于尚未焊接的 LED，如果吸湿剂或包装失效，或者产品没有符合以上有效存储条件，烘焙可以起到一定的性能恢复效果。烘焙条件：(80±5)℃，持续 24 小时。

If the moisture absorbent material has fade away or the LEDs have exceeded the storage time, baking treatment should be performed based on the following condition: (80±5)℃ for 24 hours.

2. 静电:

Static Electricity

静电和电涌会导致产品特性发生改变，例如正向电压降低等，如果情况严重甚至会损毁产品。所以在使用时必须采取有效的防静电措施。

所有相关的设备和机器都应该正确接地，同时必须采取其他防止静电和电涌的措施。

使用防静电手环，防静电垫子，防静电工作服、工作鞋、手套，防静电容器，都是有效的防止静电和电涌的措施。

Static electricity or surge voltage damages the LEDs. Damaged LEDs will show some unusual characteristic such as the forward voltage becomes lower, or the LEDs do not light at the low current. even not light.

All devices, equipment and machinery must be properly grounded. At the same time, it is recommended that wrist bands or anti-electrostatic gloves, anti-electrostatic containers be used when dealing with the LEDs.

3. 硫化:

Vulcanization

LED 硫化是由于环境中的硫进入支架内部与+1 价的银发生化学反应生成黑色 Ag_2S 的过程。该过程会导致支架镀银层的反光能力下降, 色温漂移和光衰严重, 很大程度上影响了产品性能。因此, 在使用时应注意采取相应的防硫措施, 如避免使用挥发性强的含硫物质, 避免接触含硫较高的物质。

LED curing is due to sulfur being in bracket and the +1 price of silver in the chemical reaction generated Ag_2S in the process. It will lead to the capacity of reflecting of silver layer reducing, light color temperature drift and serious decline, seriously affecting the performance of the product. So we should take corresponding measures to avoiding vulcanization, such as to avoid using sulphur volatile substances and keeping away from high sulphur content of the material.

4. 眼睛保护忠告:

Safety Advice For Human Eyes

LED 发光时, 请勿直视发光光源, 特别是对于一些光强较高的 LED, 强光可能伤害你的眼睛。

Viewing direct to the light emitting center of the LEDs, especially those of great Luminous Intensity will cause great hazard to human eyes. Please be careful.

5. 设计建议:

Design Consideration

设计电路时, 通过 LED 的电流不能超过规定的最大值, 同时, 还需使用保护电阻, 否则, 微小的电压变化将会引起较大的电流变化, 可能导致产品损毁。

建议使用以下 (A) 电路, 该电路能够很好的调节通过每个 LED 的电流; 不推荐使用 (B) 电路, 该电路在持续的电压驱动下, LED 的正向电压 (V_F) 发生变化, 电流会随之而发生变化, 可能使某些 LED 承受高于规定的电流值。

In designing a circuit, the current through each LED must not exceed the absolute maximum rating specified for each LED. In the meanwhile, resistors for protection should be applied, otherwise slight voltage shift will cause big current change, burn out may happen.

It is recommended to use Circuit A which regulates the current flowing through each LED rather than Circuit B. When driving LEDs with a constant voltage in Circuit B, the current through the LEDs may vary due to the variation in Forward Voltage (V_F) of the LEDs. In the worst case, some LED may be subjected to stresses in excess of the Absolute Maximum Rating.

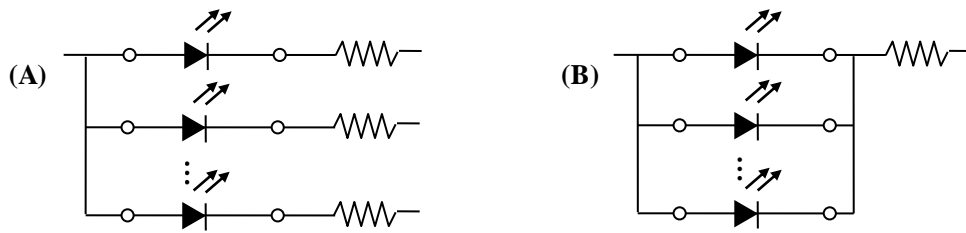

LED 的特性容易因为自身的发热和环境的温度的改变而发生改变。温度的升高会降低 LED 的发光效率、影响发光颜色等，所以在设计时应充分考虑散热的问题。

Thermal Design is paramount importance because heat generation may result in the Characteristics decline, such as brightness decreased, Color changed and so on. Please consider the heat generation of the LEDs when making the system design.

6. 其他事项:

Others

直接用手拿取产品不但会污染封装树脂表面，也可能由于静电等因素导致产品性能的改变。过度的压力也可能直接影响封装内部的管芯和金线，因此请勿对产品施加过度压力，特别当产品处于高温状态下，例如在回流焊接过程中。

When handling the product, touching the encapsulant with bare hands will not only contaminate its surface, but also affect on its optical characteristic. Excessive force to the encapsulant might result in catastrophic failure of the LEDs due to die breakage or wire deformation. For this reason, please do not put excessive stress on LEDs, especially when the LEDs are heated such as during Reflow Soldering.

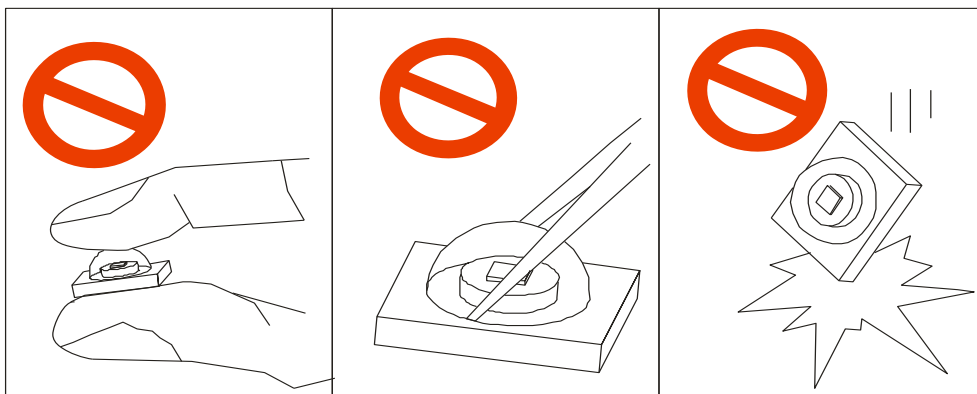

LED 的硅树脂封装部分相当脆弱，请勿用坚硬、尖锐的物体刮、擦封装树脂部分。在用镊子夹取的时候也应当小心注意。

The silicon resin of encapsulant is fragile, so please avoid scratch or friction over the epoxy resin surface. While handling the product with tweezers, do not hold by the epoxy resin, be careful.

附录：分档标准

Appendix: Grading Standard

IF=350mA(Ta=25℃)

光功率 Φ_e (mW)		峰值波长 λ_p (nm)	电压 (V)	
↙		↓	↘	
最小值	最大值	符号(AX)	最小值	
...	
400	500	A9	3.2	
500	600	A10	3.4	
600	700	A11	3.6	
700	800	A12	3.8	
...	
		A13		
		A14		
		A15		
		A16		
		A17		
		A18		
		...		

注：1、光功率仪器误差 $\pm 10\%$ ，峰值波长仪器误差 $\pm 1\text{nm}$ ，电压仪器误差 $\pm 0.1\text{V}$ 。

产品变更历史

变更类型	版本号	变更日期	变更内容
规格书变更	A0	2017-12-29	整合近紫外新规格原始版