SPECIFICATION

Model. NO: IE-2012Y-SB-C-11

REV NO: V1.0

Description:

- 2.0×1.25mm Chip SMD
- Colloid Color: Water Transparent
- Emission Color: Yellow
- Viewing Angle :120°

1. Dimensions

(Units): (mm)

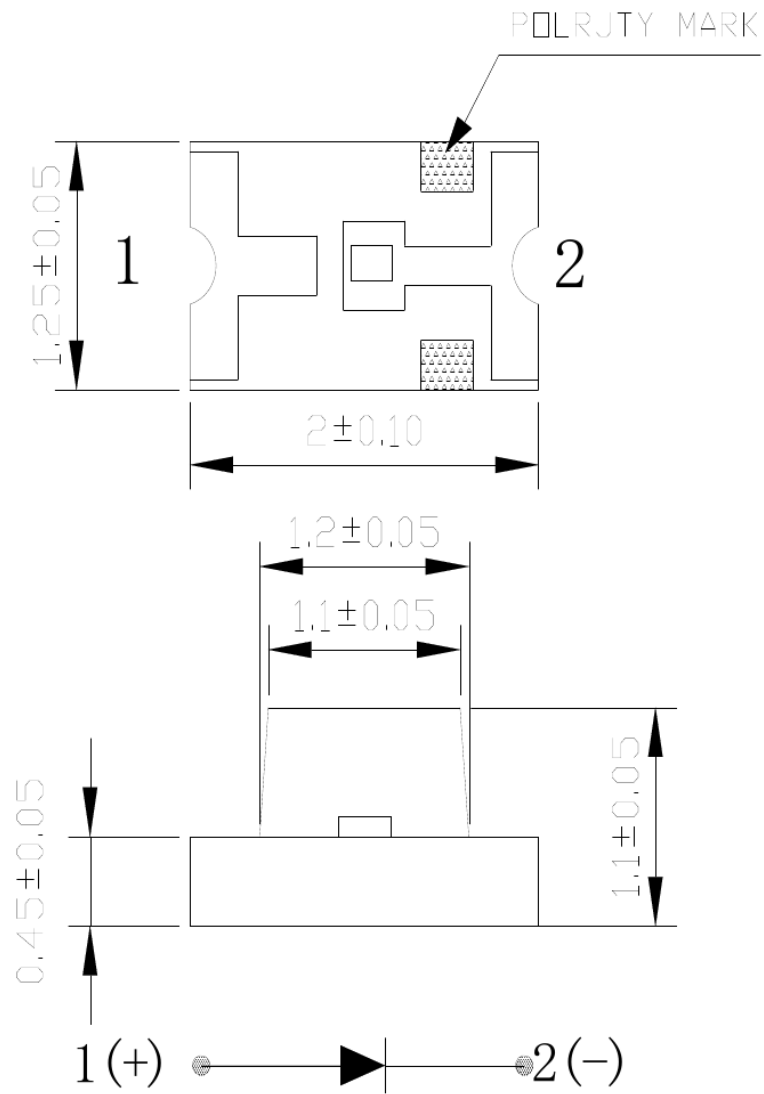

All dimensions area in mm tolerance is ± 0.05 mm unless otherwise noted.

2. Electrical / Optical characteristics

(1) Absolute Maximum Ratings (TA=25° C)

Item	Symbol	Absolute Maximum Rating	Unit
Forward Current	IF	50	mA
Pulse Forward Current	IFP	195	mA
Reverse Voltage	VR	9	V
Power Dissipation	PD	350	mW
Operating Temperature	Topr	-40° C To +85° C	°C
Storage Temperature	Tstg	-40° C To +85° C	°C
Soldering Temperature	Tsld	Reflow Soldering: 260° C Hand Soldering : 350° C	for 10sec. for 3sec.

IFP Conditions : 1/10 Duty Cycle, 0.1 msec Pulse Width.

(2) Initial Electrical/Optical Characteristics (TA=25° C)

Symbol	Item	Units	Min.	Typ.	Max.	Test Conditions
VF	Forward Current	V	1.8		2.0	IF=20mA
IR	Reverse Current	uA	-	-	10	VR=9V
$\Delta\lambda/2$	Viewing Angle	°	-	120°	-	IF=20mA
IV	Luminous Intensity	Mcd	94.7	-	123	IF=20mA
λD	Dominate Wavelength	Nm	585		592	IF=20mA

Tolerance of measurement of Vf is ± 0.05 V..

Luminous Intensity Measurement allowance is $\pm 10\%$.

Color Coordinates Measurement allowance is ± 1 nm.

(3) Luminous Intensity Ranking (TA=25° C)

Item	Symbol	Test Conditions	Min.	Max.	Units
Luminous Intensity	Iv	IF=20mA	90	120	Mcd

Luminous Intensity Measurement allowance is $\pm 10\%$.

Above are the reference for minimum and maximum of luminous intensity which rank in the rate of 1:1.3 in the process of light splitting when manufacturing massively.

(4) Color Coordinates Ranking (TA=25° C)

Item	Symbol	Test Conditions	Min.	Max.	Units
Dominate Wavelength	λD	IF=20mA	585	592.5	Nm

Color Coordinates Measurement allowance is $\pm 0.5\text{nm}$.

Above are the reference for minimum and maximum of wavelength, while it ranks as:R:5nm/G:2.5nm/B:2.5nm, when light splitting in mass manufacturing.

3. Characteristic curve

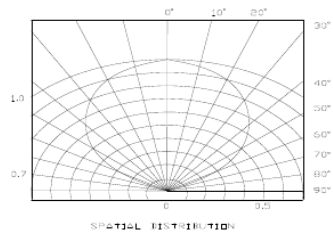
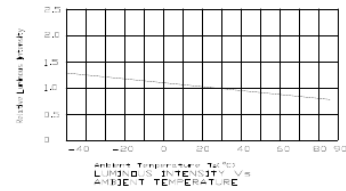
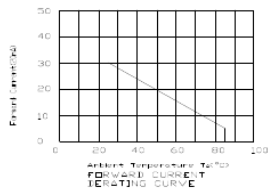
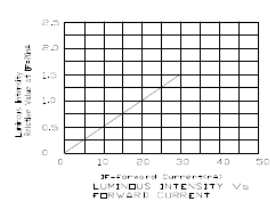
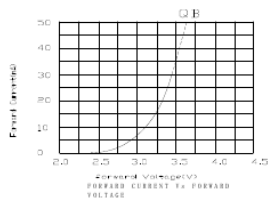
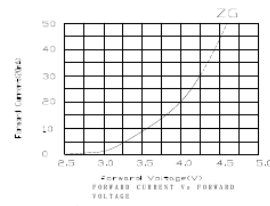
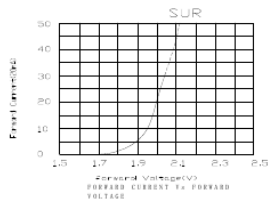
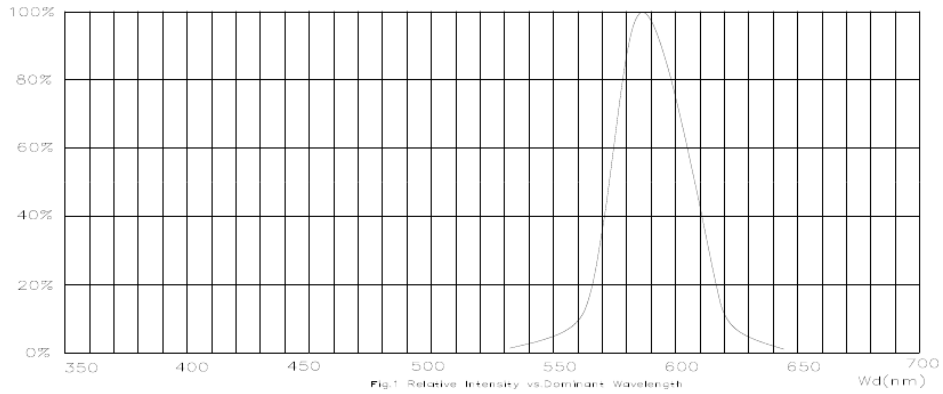

4. RELIABILITY

(1) Test Items and Results

Test Item	Standard Test Method	Test Conditions	Note	Number of Damaged
Resistance to Soldering Heat (Reflow Soldering)	JEITA ED-4701 300 301	Tsld=260°C, 10sec. (Pre treatment 30°C,70%,168hrs)	2 times	0/50
Solderability (Reflow Soldering)	JEITA ED-4701 300 303	Tsld=215±5°C, 3sec. (Leader Solder)	1time over 95%	0/50
Thermal Shock	JEITA ED-4701 300 307	-40°C~100°C 5min. 5min.	100cycles	0/50
Temperature Cycle	JEITA ED-4701 100 105	-40°C~25°C~100°C~25°C 30min. 5min. 30min. 5min.	100cycles	0/50
Moisture Resistance Cycle	JEITA ED-4701 200 203	25°C~65°C~10°C 90%RH 24hrs./1cycle	10 cycles	0/50
High Temperature Storage	JEITA ED-4701 200 201	Ta=100°C	1000 hrs	0/50
High Temperature High Humidity Storage	JEITA ED-4701 100 103	Ta=60°C, 90%RH	1000 hrs	0/50
Low Temperature Storage	JEITA ED-4701 200 202	Ta=-40°C	1000 hrs	0/50
Steady State Operating Life		Ta=25°C, If=60MA	1000 hrs	0/50
Steady State Operating Life of High Temperature		Ta=85°C, If=60MA	1000 hrs	0/50
Steady State Operating Life of High Humidity Heat		60°C, 90%RH, If=160MA	500 hrs	0/50
Steady State Operating Life of Low Temperature		Ta=-30°C, If=60MA	1000 hrs	0/50
Drop		H=75cm	3 cycles	0/50
Substrate Bending	JEITA ED-4702	3mm, 5 ± 1 sec.	1 time	0/50
Stick	JEITA ED-4702	5N, 10 ± 1 sec.	1 time	0/50

(2) Criteria For Judging Damage

Item	Symbol	Test Conditions	Criteria for Judgement	
			Min.	Max.
Forward Voltage	V _F	I _F =3x20MA	-	U.S.L.*)X1.1
Reverse Current	I _R	V _R =5V	-	U.S.L.*)X2.0
Luminous Intensity	I _v	I _F =3x20MA	L.S.L.***)X0.7	-

*) U.S.L.: Upper Standard Level

**) L.S.L.: Lower Standard Level

5. Cautions

(1) Soldering Conditions

Number of reflow process shall be less than 2 times and cooling process to normal temperature is required between first and Second soldering process.

(Recommended soldering conditions)

	Reflow Soldering		Hand Soldering	
	Lead Solder	Lead-free Solder	Temperature	350°C Max.
Pre-heat	140 ~ 160°C	180 ~ 200°C	Soldering time	3 sec. Max.
Pre-heat time	120 sec. Max.	120 sec. Max.		(one time only)
Peak temperature	230°C Max.	260°C Max.		
Soldering time	10 sec. Max.	10 sec. Max.		

(Lead Solder)

(Lead-Free Solder)

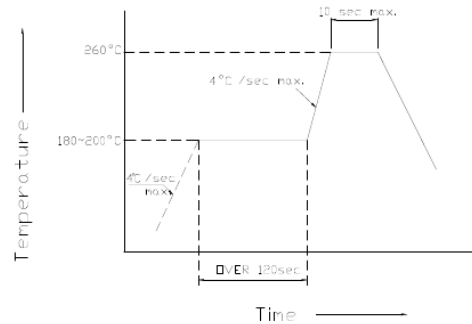
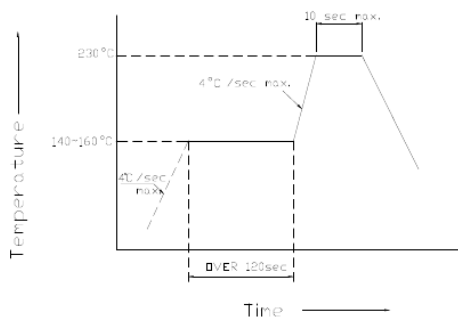

(Recommended Soldering Pattern)

(Units:mm)

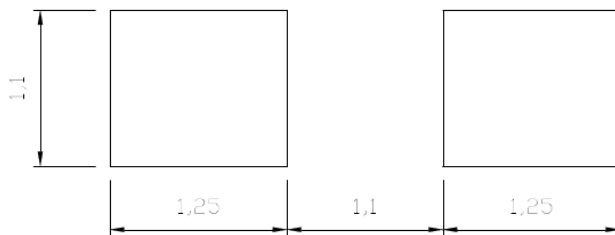

(2) Static Electricity

It is recommended that a wrist band or an anti-electrostatic glove be used when handling the LEDs.

All devices, equipment and machinery must be properly grounded.

Damaged LEDs will show some unusual characteristics such as the forward voltage becomes lower, or the LEDs do not light at the low current. Criteria : (VF > 2.0V at IF=0.5mA)

(3) Moisture Proof Package

It is recommended that moisture proof package be used .

(4) Storage

Before opening the package ,The LEDs should be kept at 30°C or less and 70%RH or less. The LEDs should be used within a year.

(5) After opening the package, The LEDs should be soldered within 24 hours (1days) after opening the package. If unused LEDs remain, they should be stored in moisture proof packages, such as sealed containers with packages of moisture absorbent material (silica gel).

If the moisture absorbent material (silica gel) has faded away or the LEDs have exceeded the storage time, baking treatment should be performed using the following conditions Baking treatment : more than 12 hours at $75 \pm 5^{\circ}\text{C}$.

(6) Label details:

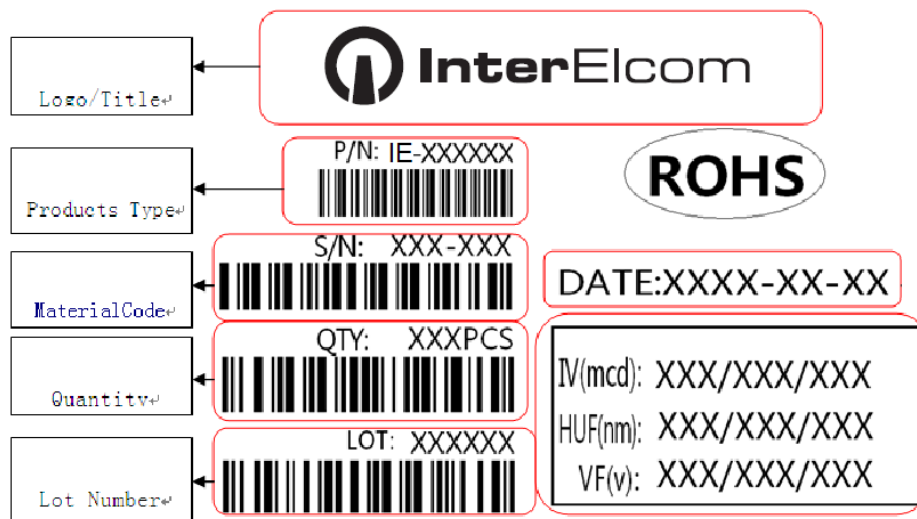

6. PACKAGING

- (1) The LEDs are packed in cardboard boxes after taping.
- (2) Taping Specifications (Units:mm)

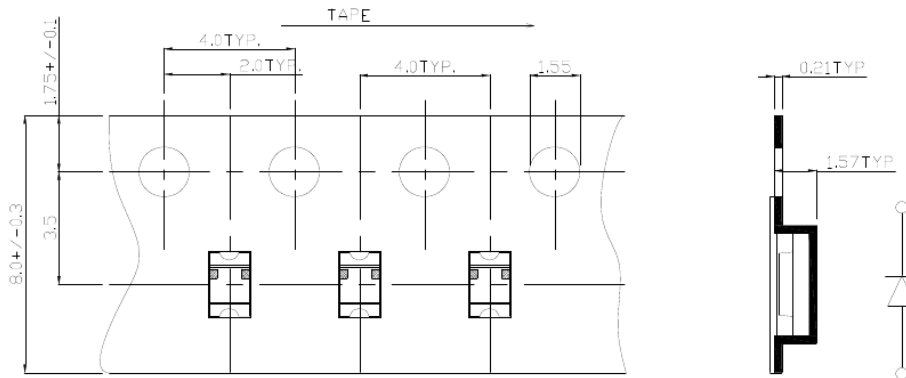

- (3) Reel Dimension

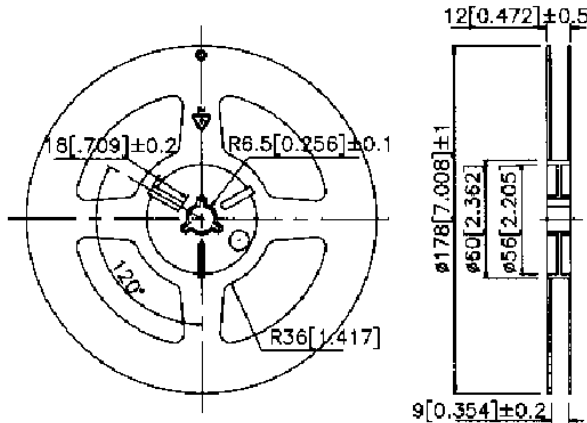

PACKAGE: 3000Pcs/Reel

- (4) The label on the minimum packing unit shows ; Part Number, Lot Number, Ranking, Quantity.
- (5) Keep away from water, moisture in order to protect the LEDs.
- (6) The LEDs may be damaged if the boxes are dropped or receive a strong impact against them. so precautions must be taken to prevent any damage.