

### Specification for approval

PART NO.	IE-2012B-SB-C-08
PART NUMBER	0805 Blue
ISSUE DATE	2017-04-21



RoHS

Customer confirm and sign

TESTED BY	CHECKED BY	APPROVED BY

INSPECT RESULT	ACCEPT	REJECT
----------------	--------	--------

REMARK

## Features

- Long operating life
- Low Power Consumption
- Wide Viewing Angle
- Low voltage DC operated
- RoHS Compliant



## Application

- Backlight
- Decoration lighting
- motormeter
- Indicator

Part Number	Dice Material	Emitted Color	Lens Color
IE-2012B-SB-C-08	InGaN	Blue	Water Clear

## Electro-Optical Characteristics(Ta=25°C, @20mA)

Parameter	Symbol	Min.	Typ.	Max.	Unit
Luminous Intensity	IV	180	-	250	mcd
Radiation Bandwidth	$\Delta\lambda$	-	35	-	nm
Forward Voltage	VF	2.90	3.00	3.40	v
Luminous Flux	$\Phi$	-	-	-	Lm
Dominant Wavelength	$\lambda_d$	460	465	475	nm
CIE Coordinates CIE	x,y	-	-	-	-
Color Temperature	Tc	-	-	-	k
Viewing Angle	2 $\theta$ 1/2	-	120	-	deg
Reverse Current	IR	-	-	10	$\mu$ A

## Absolute Maximum Ratings(Ta=25°C)

Parameter	Symbol	Max.	Unit
Peak Forward Current(1/10 Duty Cycle, 0.1ms Pulse Width)	IPF	100	mA
Forward Current	IF	30	mA
Reverse Voltage	VR	5	v
Operating Temperature Range	Topr	-40to+90	°C
Storage Temperature Range	Tstg	-40to+90	°C
Reflow Soldering	Tsld	260°C for 10secs	

# Optical & Electrical Characteristics

Spectrum Distribution

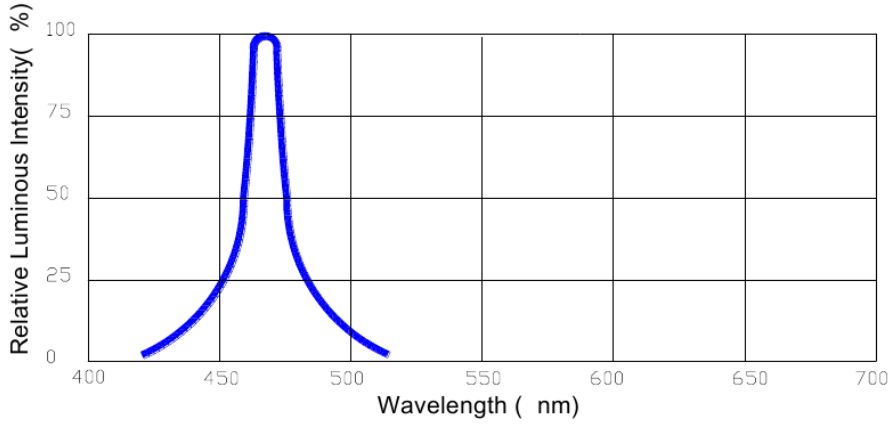

Forward Current vs. Forward Voltage      Forward Current vs. Ambient Temperature

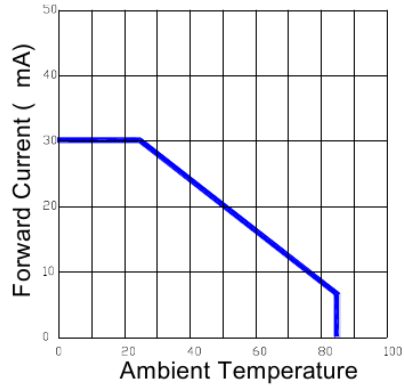
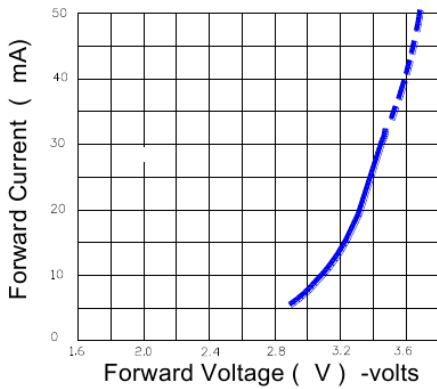

Relative Luminous Intensity vs. Forward Current

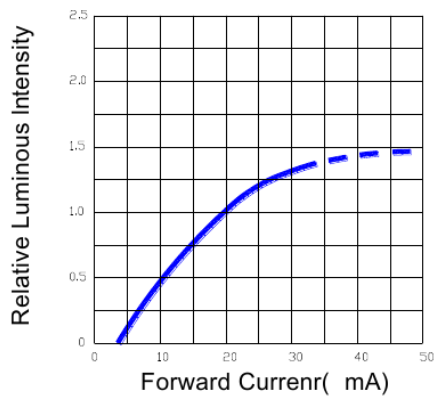

Radiation Diagram

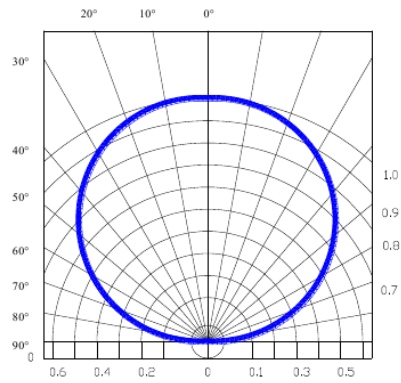

## Bin Limits

### Bin Range Of Luminous Intensity (Unit:mcd)

Bin Code	Min	Max	Condition
L1	180	250	IF=20mA
L2	-	-	
L3	-	-	

### Bin Range Of Forward Voltage (Unit:V)

Bin Code	Min	Max	Condition
V1	2.9	3.0	IF=20mA
V2	3.0	3.1	
V3	3.1	3.2	
V4	3.2	3.3	
V5	3.3	3.4	

### Bin Range Of Wavelength (Unit:nm)

Bin Code	Min	Max	Condition
B1	460	462.5	IF=20mA
B2	462.5	465	
B3	465	467.5	
B4	467.5	470	
B5	470	472.5	
B6	472.5	475	

#### Notes:

- 1.Tolerance of Luminous Intensity  $\pm 10\%$
- 2.Tolerance of Forward Voltage  $\pm 0.1V$

## Reliability Test Items And Conditions

Test Items	Reference	Test Conditions	Time	Quantity	Criterion
Thermal Shock	MIL-STD-202G	-40℃ ( 30min ) ~100℃ ( 30min )	100 Cycles	22	0/22
Temperature And Humidity Cyclic	JEITA ED-4701 200 203	-10℃~65℃ ; 0%~90%RH	10cycles	22	0/22
High Temperature Storage	JEITA ED -4071 200 201	Ta=100℃	1000H	22	0/22
Low Temperature Storage	JEITA ED -4071 200 202	Ta=-40℃	1000H	22	0/22
High Temperature High Humidity Storage	JEITA ED -4071 100 103	Ta=60℃ ; RH=90%	1000H	22	0/22
High Temperature Life Test	JESD22-A108D	Ta=80℃	1000H	22	0/22
Life Test	JESD22-A108D	Ta=25℃ IF=20mA	1000H	22	0/22
Resistance to Sodering Heat	GB/T 4937, II , 2.2&2.3	Tsol*=(240±5)℃ 10secs	2次 2 times	22	0/22

## Criteria For Judging Damage

Test Items	Symbol	Test Conditions	Criteria For Judging Damage
Forward Voltage	V <sub>F</sub>	I <sub>F</sub> =I <sub>FT</sub>	Initial Data±10%
Recerse Current	I <sub>R</sub>	V <sub>R</sub> =5V	I <sub>R</sub> ≤10uA
Luminous Intensity	I <sub>V</sub>	I <sub>F</sub> =I <sub>FT</sub>	Average I <sub>V</sub> degradation≤30% ; Single LED I <sub>V</sub> degradation≤50%
Resistance to Soldering Heat			Material without internal cracks,no material between stripped,no deaded light

**product size**

**(Unit : mm)**

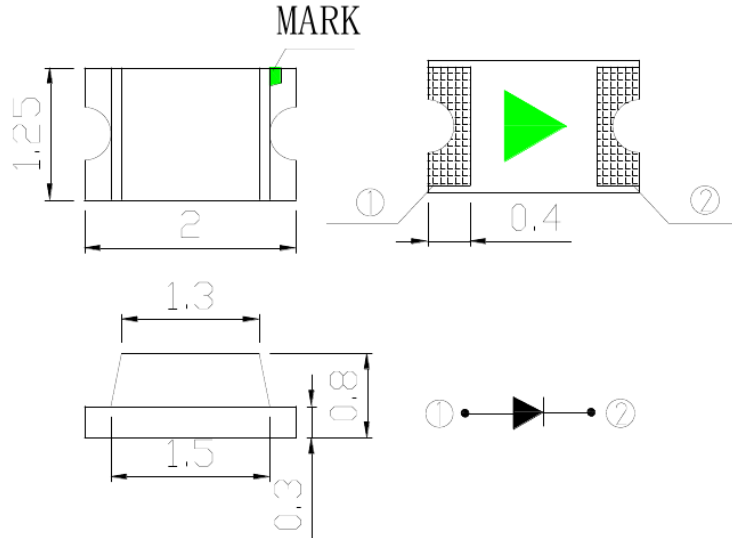

**NOTES**

1. All dimensions are in millimeters (inches)
2. Tolerances are  $\pm 0.2\text{mm}$  (0.008inch) unless otherwise noted.

**Recommended Soldering Pad Design**

**(Unit : mm)**

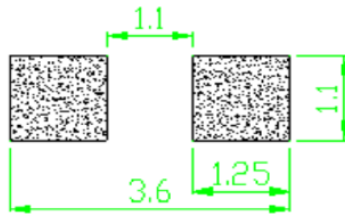

**Taping and package Spec**

- Tape Specification:3,000pcs Per Reel

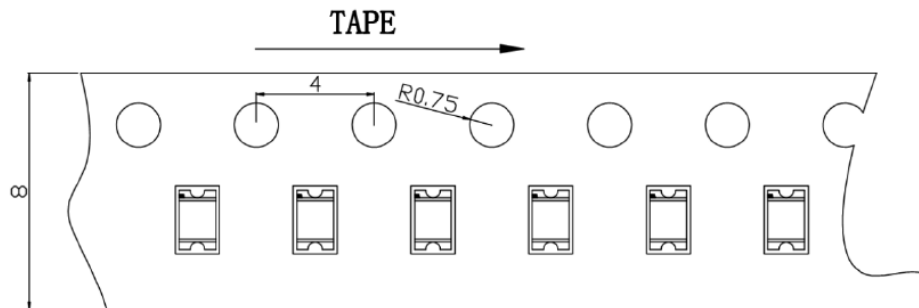

# Packaging

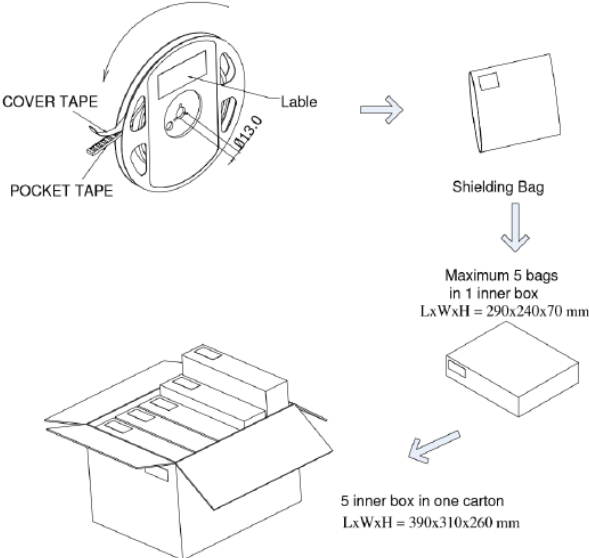

## Useful hint

### Reflow Soldering Instructions

Lead Solder

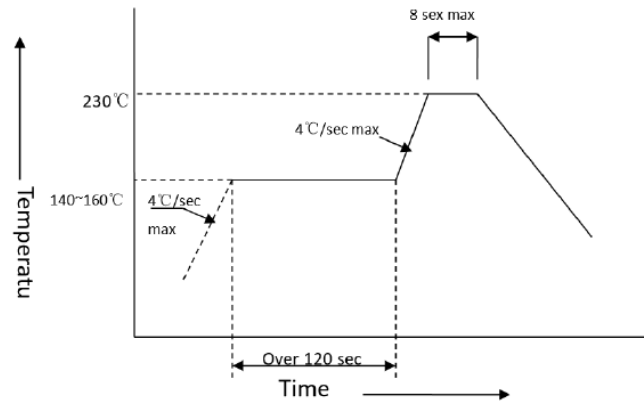

Lead-Free Solder

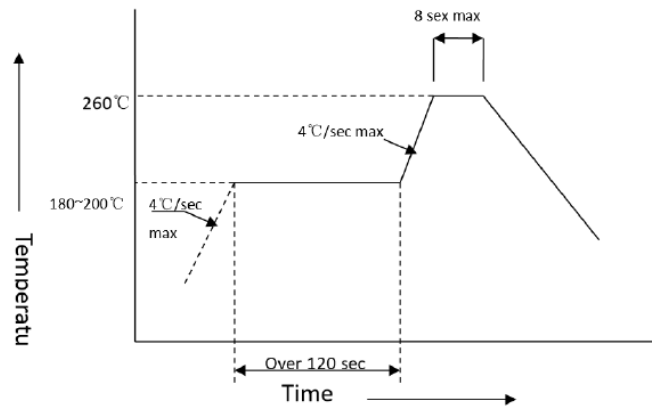

- Reflow soldering should not be done more than two times
- Stress on the LEDs should be avoided during heating in soldering process
- After soldering, do not deal with the product before its temperature drop down to room Temperature.

## **Precautions**

### **1. Storage**

- 

Moisture proof and anti-electrostatic package with moisture absorbent material is used, to keep moisture to a minimum.

- 

Before opening the package, the product should be kept at 30°C or less and humidity less than 60% RH, and be used within a year.

- 

After opening the package, the product should be stored at 30°C or less and humidity less than 10%RH, and be soldered within 24 hours (1day). It is recommended that the product be operated at the workshop condition of 30°C or less and humidity less than 60%RH.

- 

If the moisture absorbent material has faded away or the LEDs have exceeded the storage time, baking treatment should be performed based on the following condition: (70±5)°C for 24 hours.

### **2. Static Electricity**

Static electricity or surge voltage damages the LEDs. Damaged LEDs will show some unusual characteristics such as the forward voltage becoming lower, or the LEDs do not light at the low current, even not light.

All devices, equipment and machinery must be properly grounded. At the same time, it is recommended that wrist bands or anti-electrostatic gloves, anti-electrostatic containers be used when dealing with the LEDs.

### **3. Vulcanization**

LED curing is due to sulfur being in brackets and the +1 price of silver in the chemical reaction generated Ag<sub>2</sub>S in the process. It will lead to the capacity of reflecting of silver layer reducing, light color temperature drift and serious decline, seriously affecting the performance of the product. So we should take corresponding measures to avoid vulcanization, such as to avoid using sulphur volatile substances and keeping away from high sulphur content of the material.