

# Specification for approval

CUSTOMER NAME: \_\_\_\_\_

DIRECTOR: \_\_\_\_\_ TITLE: \_\_\_\_\_

CUSTOMER PART NO.: \_\_\_\_\_

PART NUMBER: IE-3224R-SB-L-R-C REVISION: 2.0

ISSUE DATE: 2015-3-14 RETURN DATE:  / /

We are please in sending you herewith our specification and drawings for your approval.  
Please return to us one copy "For Approval" with your approved signatures.

CUSTOMER'S PROPOSAL

- AGREE
- DISAGREE

REASON \_\_\_\_\_  
\_\_\_\_\_

CUSTOMER SIGNATURE: \_\_\_\_\_

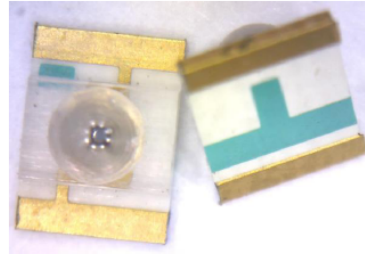

**Features**

- \_3.2mmX1.6mm SMT LED, 1.85 mm THICKNESS.
- \_LOW POWER CONSUMPTION.
- \_WIDE VIEWING ANGLE.
- \_IDEAL FOR BACKLIGHT AND INDICATOR.
- \_VARIOUS COLORS AND LENS TYPES AVAILABLE.
- \_PACKAGE: 2000PCS / REEL.
- \_RoHS COMPLIANT.

**Description**

The Hyper Red source color devices are made with DH InGaAlP on GaAs substrate Light Emitting Diode.

**Package Dimensions**

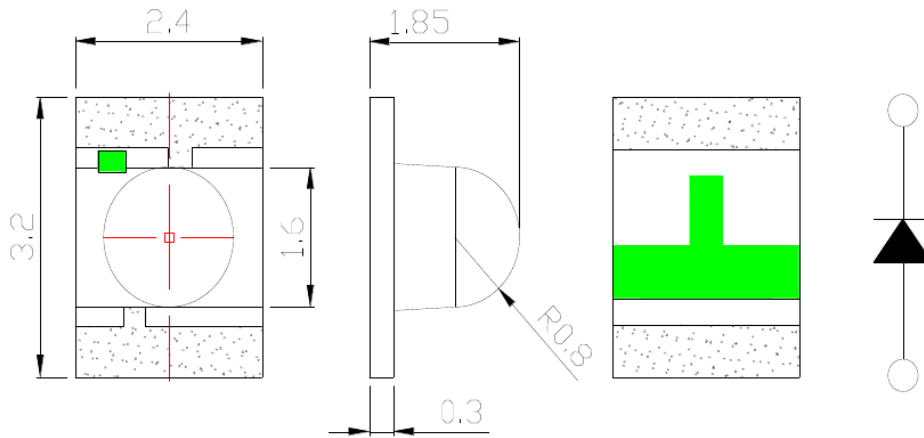

**Notes:**

1. All dimensions are in millimeters (inches).
2. Tolerance is  $\pm 0.1(0.004")$  unless otherwise noted.
3. Specifications are subject to change without notice.

**Selection Guide**

Part No.	Dice	Lens Type	Iv (mcd) @ 20mA		Viewing Angle
			Min.	Typ.	2 θ 1/2
<b>IE-3224R-SB-L-R-C</b>	<b>RED</b>	<b>WATER CLEAR</b>	<b>650</b>	<b>850</b>	<b>35</b>

**Note:**

1. θ1/2 is the angle from optical centerline where the luminous intensity is 1/2 the optical centerline value.

**Electrical / Optical Characteristics at TA=25°C**

Symbol	Parameter	Device	Typ.	Max.	Units	Test Conditions
λ <sub>peak</sub>	Peak Wavelength	RED	617	625	nm	IF=20mA
λ <sub>D</sub>	Dominant Wavelength	RED			nm	IF=20mA
Δλ <sub>1/2</sub>	Spectral Line Half-width	RED	25		nm	IF=20mA
C	Capacitance	RED	105		pF	VF=0V;f=1MHz
VF	Forward Voltage	RED	1.9	2.2	V	IF=20mA
IR	Reverse Current	RED		2	uA	VR = 7V

**Remarks:**

If special sorting is required (e.g. binning based on forward voltage, luminous intensity, or wavelength), the typical accuracy of the sorting process is as follows:

1. Wavelength: +/-1nm
2. Luminous Intensity: +/-15%
3. Forward Voltage: +/-0.1V

Note: Accuracy may depend on the sorting parameters

**Absolute Maximum Ratings at TA=25°C**

Parameter	RED	Units
Power dissipation	75	mW
DC Forward Current	30	mA
Peak Forward Current [1]	80	mA
Reverse Voltage	5	V
Operating/Storage Temperature	-40°C To +85°C	

**Note:**

1. 1/10 Duty Cycle, 0.1ms Pulse Width.

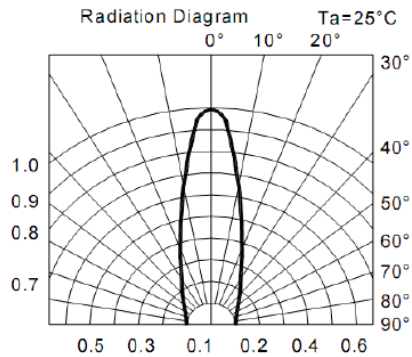
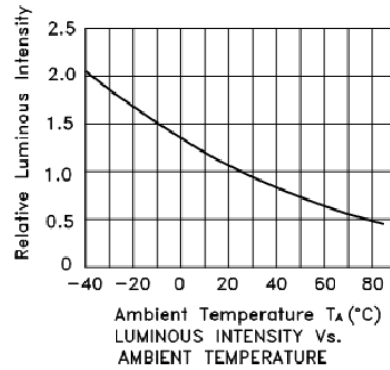
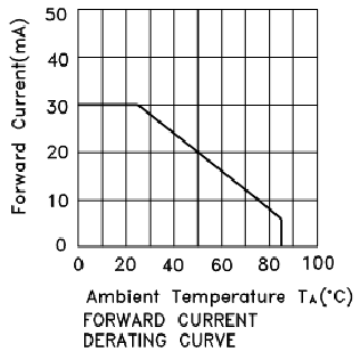
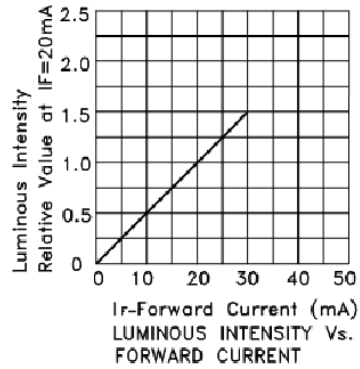
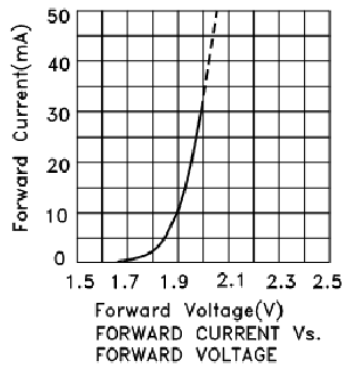
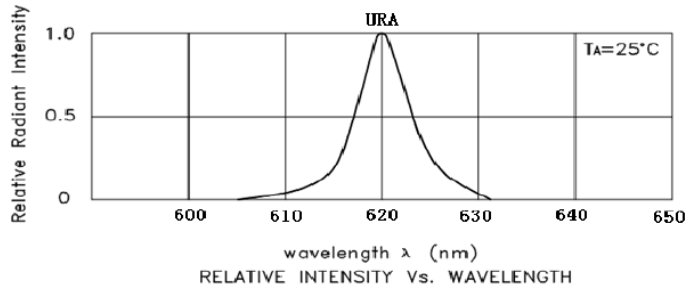

## RELIABILITY

## Test Items and Results

1		JEITA ED-4701	-40°C ~ 25°C ~ 100°C ~ 25°C 30 5 30 5	100	50	0/50
2		MIL-STD-202G	-40°C ~ 100°C 15 15	500	50	0/50
3		JEITA ED-4701 200 201	T <sub>a</sub> =100°C	1000	50	0/50
4		JEITA ED-4701 200 201	T <sub>a</sub> =-40°C	1000	50	0/50
5			T <sub>a</sub> =25±5°C I <sub>f</sub> =20mA	1000	50	0/50
6			T <sub>a</sub> =60°C RH=85% I <sub>f</sub> =20mA	1000	50	0/50
7		JEITA ED-4701 300 303	T <sub>sol</sub> =235°C±5°C,5	5	10	0/10
8		JEITA ED-4701 300 301	T <sub>sol</sub> =260°C,10 35°C 95%RH 96	10	10	0/10

5. Cautions

(1) Soldering Conditions

Number of reflow process shall be less than 2 times and cooling process to normal temperature is required between first and Second soldering process.

(Recommended soldering conditions)

Reflow Soldering			Temperature Soldering time	350° C Max. 3 sec. Max. (one time only)
	Lead Solder	Lead-free Solder		
Pre-heat	140 ~ 160° C	180 ~ 200° C		
Pre-heat time	120 sec. Max.	120 sec. Max.		
Peak temperature	230° C Max.	240° C Max.		
Soldering time	10 sec. Max.	10 sec. Max.		
Condition				

(Lead Solder)

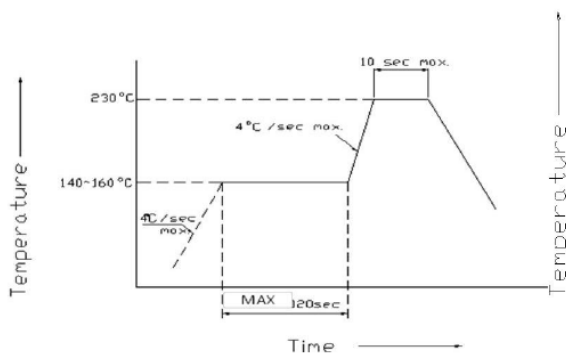

(Lead-Free Solder)

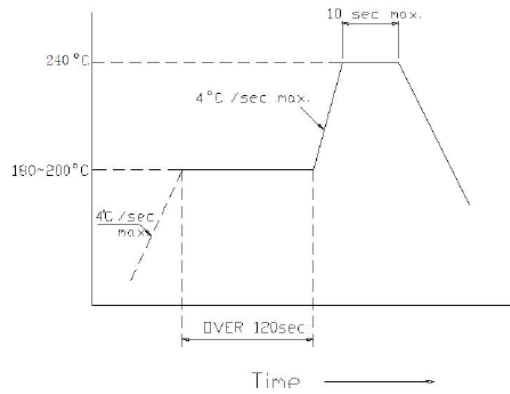

Recommended Solderir  
(Units : mm)

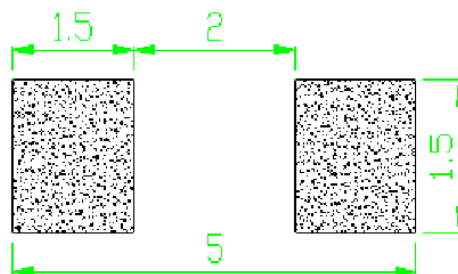

## (2) Static Electricity

It is recommended that a wrist band or an anti-electrostatic glove be used when handling the LEDs.

All devices, equipment and machinery must be properly grounded.

2.0V Damaged LEDs will show some unusual characteristics such as the forward voltage becomes lower, or the LEDs do not light at the low current. Criteria : ( $V_F > 2.0V$  at  $I_F=0.5mA$ )

## (3) Moisture Proof Package

It is recommended that moisture proof package be used .

## (4)

Cautions:

## 4.1.

Please check if there is air leak before opening the package, if so, please return the goods back to take drying process for later using.

## 4.2

Products can be used within 15days after packaging, after that, they must be:

## 4.2.1

Soldered within 24 hrs

## 4.2.2

Used in the condition:  $30^{\circ}C$  within and 60%RH below

## 4.2.3

Stored in 30%RH for moisture below.

## 4.3.

Products cannot be used for and over 15days after being packaged unless opening the package and take drying our process in  $85^{\circ}C/6H$ .

## 4.4.

Products not be used for or over 60days after being packaged please return back to take drying out and packaging process for forward using.

## 4.5.

Products not be used after opening the package need to be dried out for  $85^{\circ}C/6H$

### PACKAGING

The LEDs are packed in cardboard boxes after taping.

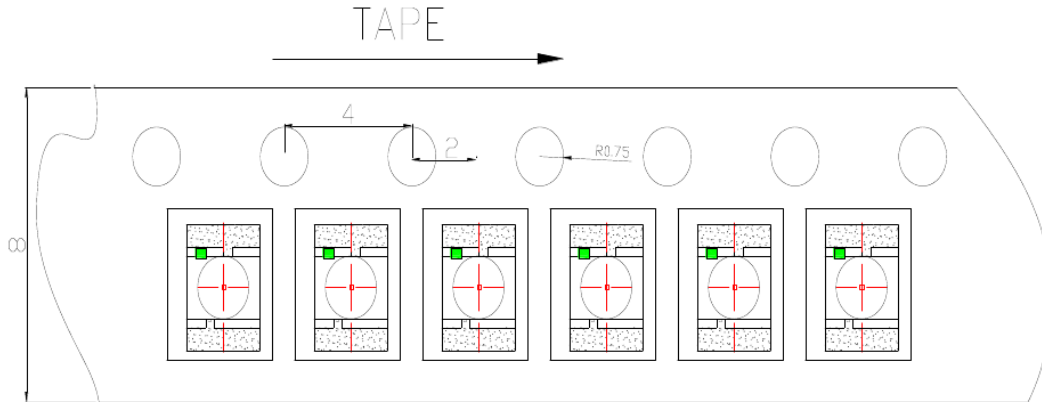

Package: 2000PCS/reel

### Reel Dimensions

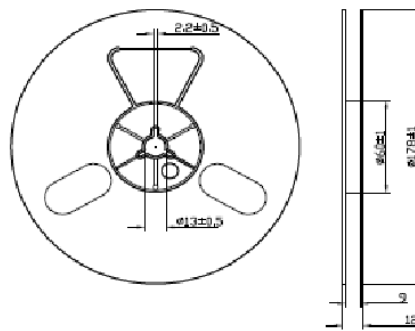

### Moisture Resistant Packaging

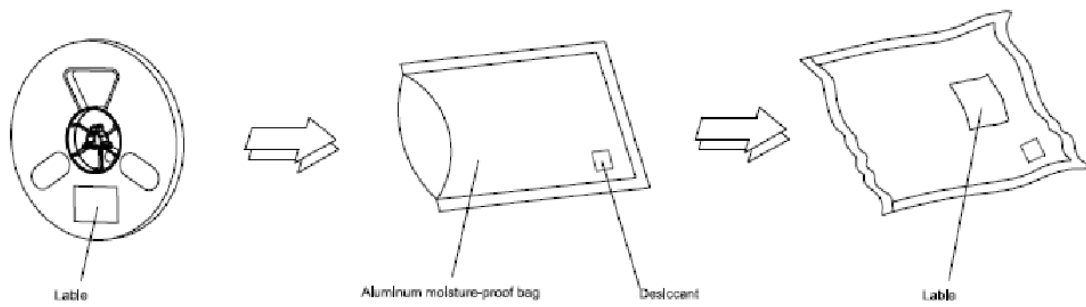

Note: The tolerances unless mentioned is  $\pm 0.1\text{mm}$ , Unit: mm