SPECIFICATION

Customer : _____
Model Name: _____ IE-A-1110CH04R24-Cx-1 _____
ERP NO. : _____
Spec Vision: _____ V.1 _____
Date: _____ 2019/03/21 _____

-
-

Approved by	Comment

Prepared by	Reviewed by	Approved by

Record of Revision

Version	Revise Date	Page	Content	Modified by
V. 1	2019.03.21	-	First Issued.	

Contents

1. General Specifications	4
2. Pin Assignment	5
3. Operation Specifications.....	6
3.1. Absolute Maximum Ratings	6
3.1.1. Recommended Operation Range	6
3.1.2. Backlight Driving Conditions	7
3.2. Power Sequence.....	8
3.2.1. Power On Sequence.....	8
3.2.2. Power Off Sequence	8
3.3. Timing Characteristics	9
3.3.1. RGB Input Timing Table	9
3.3.2. Timing Diagram.....	10
4. Optical Specifications.....	13
5. Reliability Test Items.....	14
6. Mechanical Drawing	15

1. General Specifications

NO.	Item	Specification	Remark
1	Panel Size	4.3 inch(Diagonal)	
2	Resolution	480 x 3(RGB) x 272	
3	Driver Method	A-Si TFT active matrix	
4	Active Area	95.04(W) x 53.856(H) mm	
5	Dot Pitch	0.198(W) x 0.198(H) mm	
6	Pixel Arrangement	RGB-stripe	
7	Module Size	105.4(W) x 67.1(H) x3.0(D) mm	
8	Display Mode	Normally Black	
9	Display Color	16.7M	
10	Viewing Direction	all o'clock	
11	Interface	TTL RGB-24Bit parallel interface	
12	Driving IC	ST7283	
13	Weight	TBD	g

2. Pin Assignment

No.	Symbol	Function	Remarks
1	VLED-	Power for LED backlight (Cathode)	
2	VLED+	Power for LED backlight (anode)	
3	GND	Power ground	
4	VDD	Power for digital circuit	
5-12	R0~R7	Red Data	
13-20	G0~G7	Green Data	
21~28	B0~B7	Blue Data	
29	GND	Power ground	
30	PCLK	Pixel clock	
31	DISP	Display control/standby mode selection. Disp=0,standby mode (default),DISP=1,Normal display	
32	HSYNC	Horizontal Sync input	
33	VSYNC	Vertical Sync input	
34	DE	Data input enable	
35	NC	No connection	
36	GND	Power ground	
37	NC	not connect	
38	NC	not connect	
39	NC	not connect	
40	NC	not connect	

3. Operation Specifications

3.1. Absolute Maximum Ratings

Voltage (AGND=GND=0V, Ta = 25°C)

Parameter	Min.	Max.	Unit
Power Supply Voltage V _{DD}	-0.3	+4.6	V
I/O Supply Voltage V _{DDI}	-0.3	+4.6	V
Charge Pump Supply Voltage P _{VDD}	-0.3	+4.6	V
Storage Temperature	-0.3	+4.6	V
Operating Temperature	-20	60	°C
Storage Temperature	-20	70	°C

Note: The absolute maximum rating values of this product are not allowed to be exceeded at any times. Should a module be used with any of the absolute maximum ratings case, the module may be permanently destroyed.

3.1.1. Recommended Operation Range

Parameter	Symbol	values			Unit
		Min.	Typ.	Max.	
Digital Supply Voltage	V _{DD}	3.0	3.3	3.6	V
I/O Supply Voltage	V _{DDI}	3.0	-	V _{DD}	V
Charge Pump Supply Voltage	P _{VDD}	3.0	3.3	3.6	V
Positive High-Voltage power	V _{GH}	13	15	17.5	V
Negative High-Voltage power	V _{GL}	-11.5	-10	-7	V
Standby Current	I _{sc}	-	-	50	uA
Operation Current	I _{oc}	-	20	-	mA

3.1.2. Backlight Driving Conditions

Parameter	Symbol	Min.	Typ.	Max.	Unit
Supply voltage of white LED backlight	V_L	14.5	16.5	-	V
Current for LED backlight	I_L	30	40	50	mA
Luminance (on the module surface ,BM-7)		300	350	-	cd/m ²
LED life time	-	30000	-	-	Hr

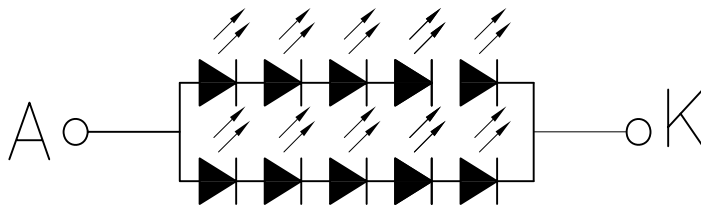

LED CIRCUIT DIAGRAM

$$V_f = 14.5V - 16.5V (I_f = 2 \times 20mA)$$

3.2. Power Sequence

3.2.1. Power On Sequence

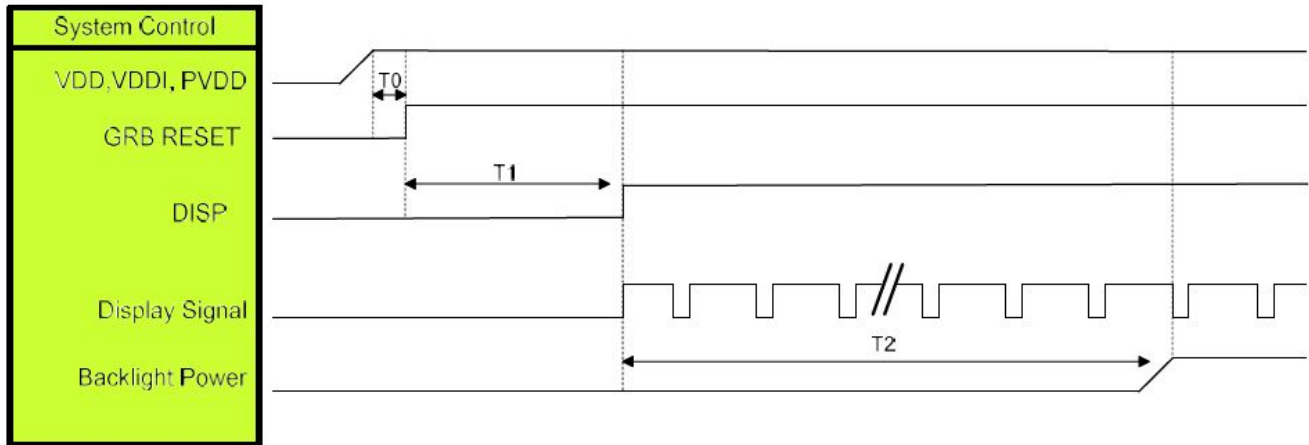

Symbol	Description	Min. Time	Unit
T0	System power stability to GRB RESET signal	0	ms
T1	GRB RESET="High" to DISP="High"	10	ms
T2	Display Signal output to Backlight Power on	250	ms

3.2.2. Power Off Sequence

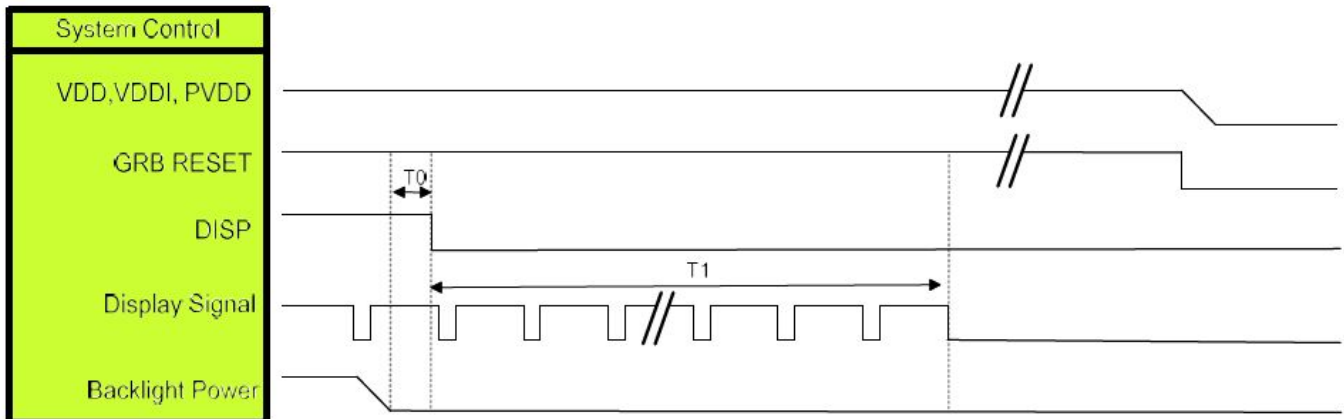

Symbol	Description	Min. Time	Unit
T0	Backlight Power off to DISP="Low"	5	ms
T1	DISP="Low" to IC internal voltage discharge complete	80	ms

3.3. Timing Characteristics

3.3.1. RGB Input Timing Table

Parallel 24-bit RGB Timing Table

480RGB X 272 Resolution Timing Table							
Item	Symbol	Min.	Typ.	Max.	Unit	Remark	
DCLK Frequency	Fclk	8	9	12	MHz		
DCLK Period	Tclk	83	111	125	ns		
HSYNC	Period Time	Th	485	531	598	DCLK	
	Display Period	Thdisp		480		DCLK	
	Back Porch	Thbp	3	43	43	DCLK	By H_BLANKING setting
	Front Porch	Thfp	2	8	75	DCLK	
	Pulse Width	Thw	2	4	43	DCLK	
VSYNC	Period Time	Tv	276	292	321	HSYNC	
	Display Period	Tvdisp		272		HSYNC	
	Back Porch	Tvbp	2	12	12	HSYNC	By V_BLANKING setting
	Front Porch	Tvfp	2	8	37	HSYNC	
	Pulse Width	Tvw	2	4	12	HSYNC	

Note: It is necessary to keep Tvbp =12 and Thbp =43 in sync mode. DE mode is unnecessary to keep it.

Serial 8-bit RGB Timing Table

480RGB X 272 Resolution Timing Table							
Item	Symbol	Min.	Typ.	Max.	Unit	Remark	
DCLK Frequency	Fclk	24	27	30	MHz		
DCLK Period	Tclk	33	37	42	ns		
HSYNC	Period Time	Th	1445	1491	1558	DCLK	
	Display Period	Thdisp		1440		DCLK	
	Back Porch	Thbp	3	43	43	DCLK	By H_BLANKING setting
	Front Porch	Thfp	2	8	75	DCLK	
	Pulse Width	Thw	2	4	43	DCLK	
VSYNC	Period Time	Tv	276	292	321	HSYNC	
	Display Period	Tvdisp		272		HSYNC	
	Back Porch	Tvbp	2	12	12	HSYNC	By V_BLANKING setting
	Front Porch	Tvfp	2	8	37	HSYNC	
	Pulse Width	Tvw	2	4	12	HSYNC	

Note: It is necessary to keep Tvbp =12 and Thbp =43 in sync mode. DE mode is unnecessary to keep it.

3.3.2. Timing Diagram

SYNC Mode Timing Diagram

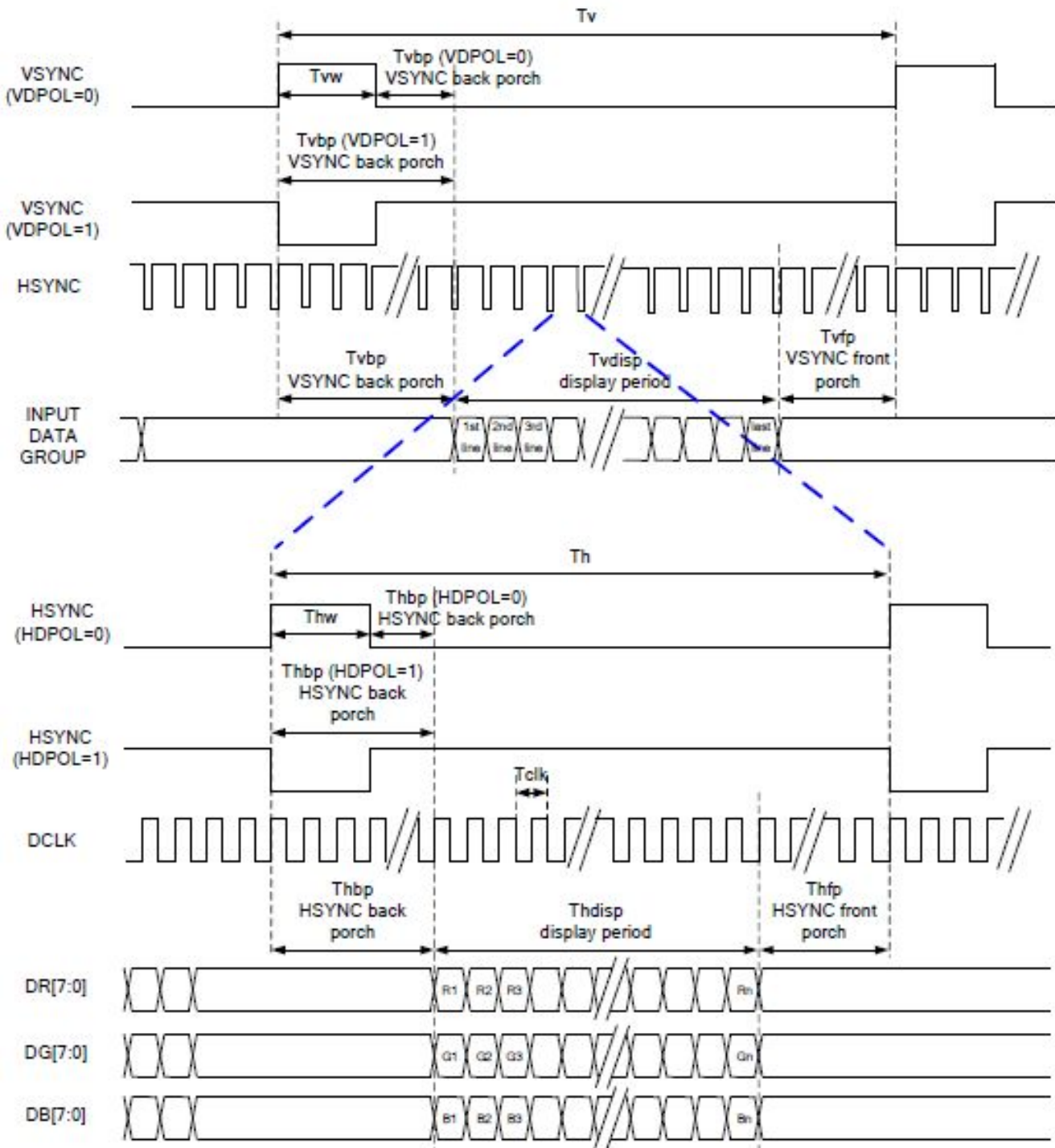

SYNC-DE Mode Timing Diagram

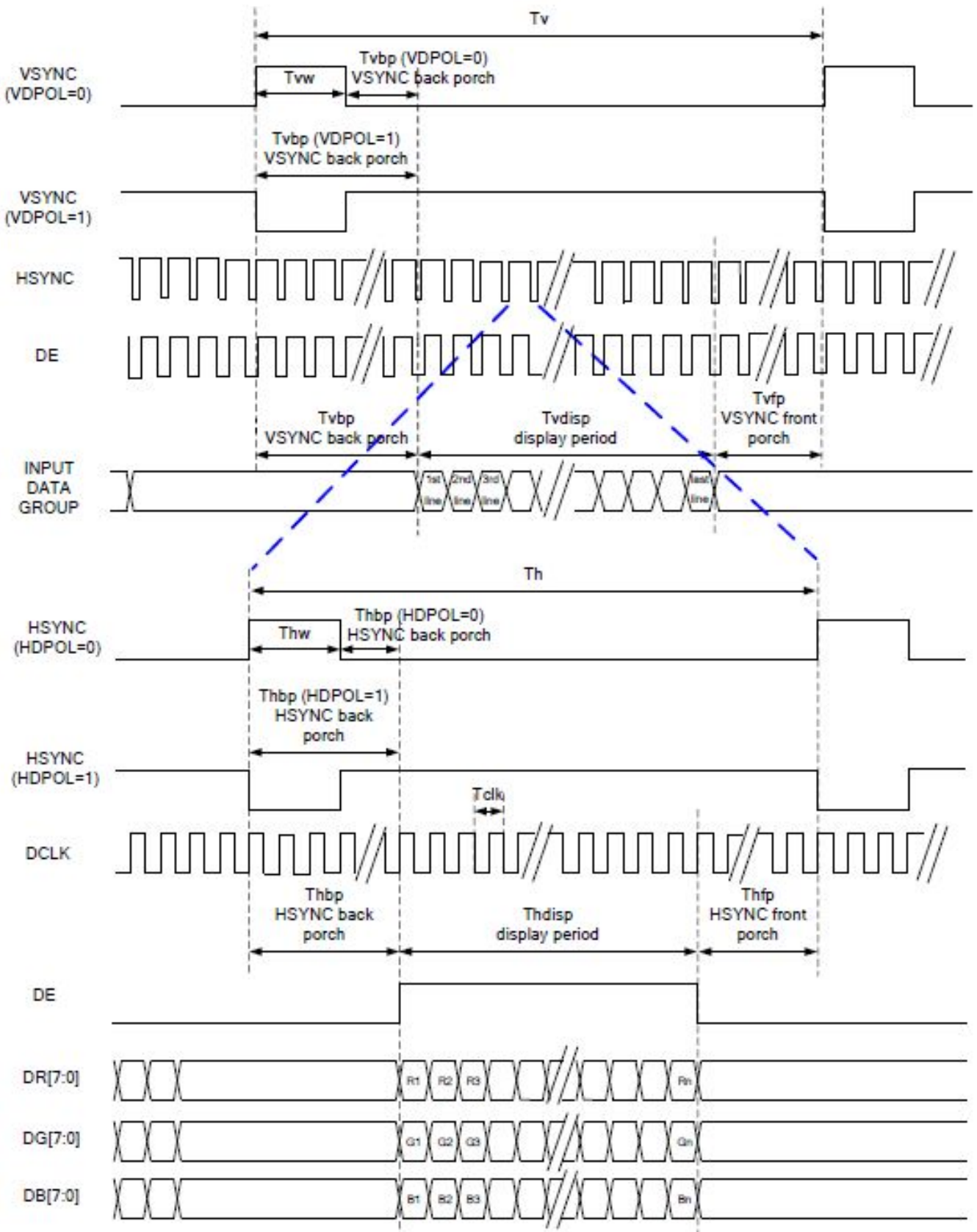

DE Mode Timing Diagram

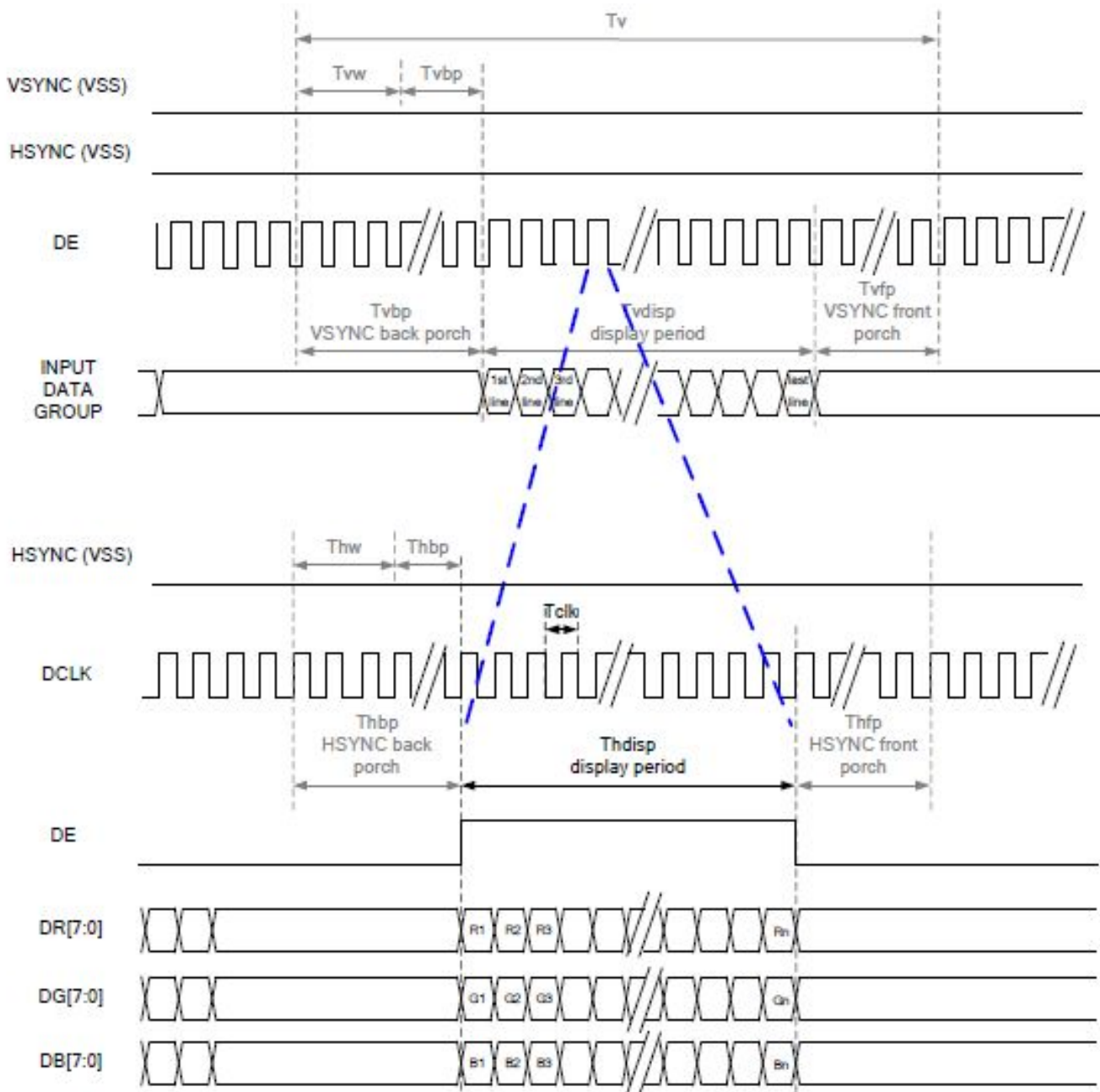

RGB Mode Selection Table	DCLK	HSYNC	VSYNC	DE
SYNC - DE Mode	Input	Input	Input	Input
SYNC Mode	Input	Input	Input	GND
DE Mode	Input	GND	GND	Input

Note: "Input" means these signals are driven by host side.

4. Optical Specifications

Item		Symbol	Min.	Typ.	Max.	Unit	Note
Contrast Ratio		CR	600	800	-	-	
Color gamut (NTSC ratio)		-	-	48.1	-	%	
Response Time		Rising + Falling	-	30	40	ms	
Viewing Angle	Horizontal	θx^+	70	80	-	degree	
		θx^-	70	80	-		
	Vertical	θy^+	70	80	-		
		θy^-	70	80	-		
Color Filter Chromaticity (CIE1931)	Red	X	-0.03	0.573	+0.03	-	
		Y		0.332			
	Green	X		0.369			
		Y		0.566			
	Blue	X		0.147			
		Y		0.075			
	White	X		0.32			
		Y		0.37			
Luminance (center)		L	300	350	-	cd/m2	
Luminance Uniformity		ΔL	75	80		%	

Test Condition:

- 1、VDD=3.3V,IL=20mA(Backlight current), the ambient temperature is 25°C.

5. Reliability Test Items

Item	Test Conditions	Remark
High Temperature Storage	Ta=70℃ 120h	Note1 ,Note4
Low Temperature Storage	Ta=-20℃ 120h	Note1, Note4
High Temperature Operation	Ts=60℃ 120h	Note2 ,Note4
Low Temperature Operation	Ts=-20℃ 120h	Note4
Operation at High Temperature and Humidity	+60℃,90%RH 120h	Note4
Thermal Shock	-20℃ /30min~+60℃ /30min for a total 100 cycles, Start with cold temperature and end with high temperature	
Package Drop Test	Height 60cm 1corner , 3edges , 6surfaces	
Elector Static Discharge	±2KV,Human Body Mode, 150pF/330Ω	

Note1: Ta is the ambient temperature of samples.

Note2: Ts is the temperature of panel's surfaces.

Note3: In the standard condition, there shall be no practical problem that may affect the display function. After the reliability test, the product only guarantees operation, but doesn't guarantee all of the cosmetic specification.

Note4: before cosmetic and function test, the product must have enough recovery time, at least 2 hours at room temperature.

Front View

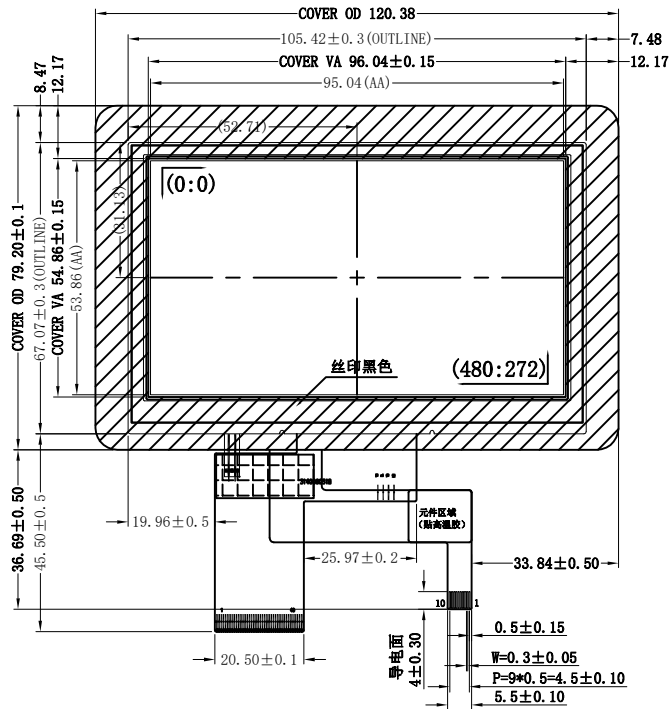

Side View

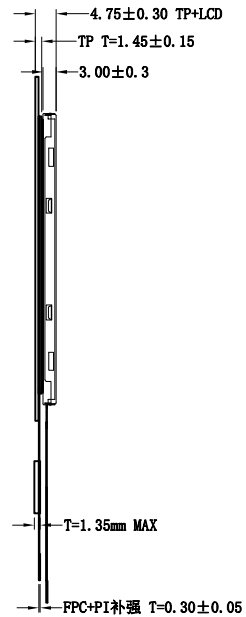

Back View

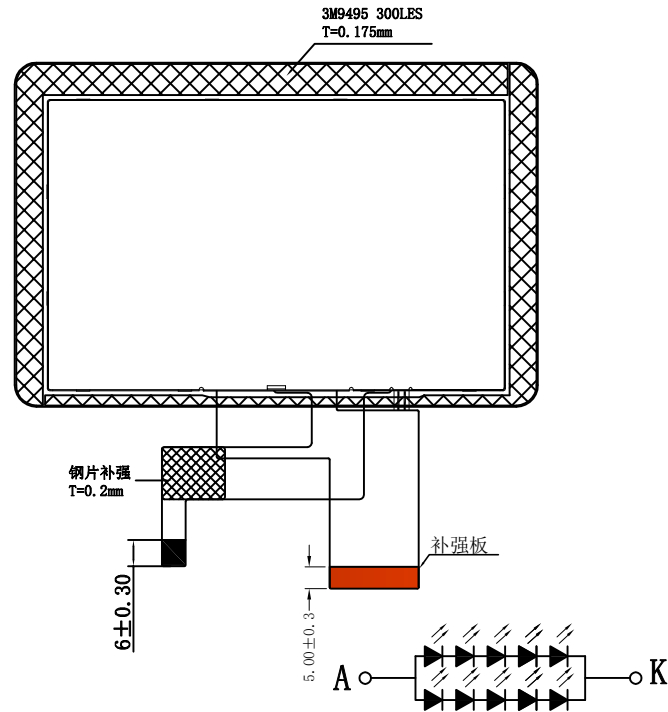

LED CIRCUIT DIAGRAM
 Vf=14.5V-16.5V (If=2*20mA)

1	LED Cathode
2	LED Anode
3	GND
4	VDD
5	R0
6	R1
7	R2
8	R3
9	R4
10	R5
11	R6
12	R7
13	G0
14	G1
15	G2
16	G3
17	G4
18	G5
19	G6
20	G7
21	B0
22	B1
23	B2
24	B3
25	B4
26	B5
27	B6
28	B7
29	GND
30	DOTCLK
31	DISP
32	HSYNC
33	VSYNC
34	DEN
35	NC
36	GND
37	NC
38	NC
39	NC
40	NC

- NOTES:
1. DISPLAY TYPE: 4.3", TFT LCD
 2. DISPLAY MODE: transmissive Normally black
 3. VIEWING DIRECTION: ALL o'clock
 4. DRIVER IC: ST7283.
- LCM (White 7 AVG 1/6):
 Brightness: 350cd/m² (TYP) (用BM-7A测)
 Chromaticity: 0.32±0.03; 0.37±0.03.
 Uniformity: 80% (MIN)
6. BACK LIGHT: 10 chip white LEDs If=40mA, Vf=14.5V~16.5V
 7. OPERATING TEMP: -20° C TO 60° C, STORAGE TEMP: -20° C TO 70° C
 8. * Critical Parameter, () ref Parameter, [] cpk Parameter
 Unspecified Tolerances: ±0.30mm
 Modification mark: Δ
 9. SUGGESTION: TP window size unilateral increase 0.3~0.5mm than LCM A.A
 10. REQUIREMENTS ENVIRONMENTAL PROTECTION: RoHS

- CTP技术要求:
1. 结构: G+G
 2. IC: FT5436
 3. 操作温度: -20° C ~ +70° C ≤90%RH
 4. 储存温度: -30° C ~ +80° C ≤90%RH
 5. 表面硬度: ≥6H
 6. 透光率: ≥86%
 7. 符合ROHS标准
 8. 未注公差: ±0.2mm.

TP PIN NAME	
1	GND
2	VDD
3	SCL
4	NC
5	SDA
6	NC
7	RST
8	NC
9	INT
10	GND

TP NO:	VER.	Mark	History	Date	Name
Customer NO:				2019.08.27	
Material code:			调整LCD	2020.08.19	
NO: 1/1		UNIT: MM			
APPROVED	CHECKED	DRAWN			