

DATA SHEET

PART NO. : IE-5R4FA13D-9C

DATE :

DEPARTMENT :

REVISION :

5.0mm Round Type LED Lamps

Model No.: **IE-5R4FA13D-9C**

ECN: _____ Page: 1/4

■ Features :

- High radiant intensity
- Choice of various viewing angles
- Reliable and robust

■ Descriptions :

- The series is specially designed for applications requiring higher brightness.
- The led lamps are available with different colors, intensities epoxy colors, etc.

■ Applications :

- TV set
- Monitor
- Telephone
- Computer

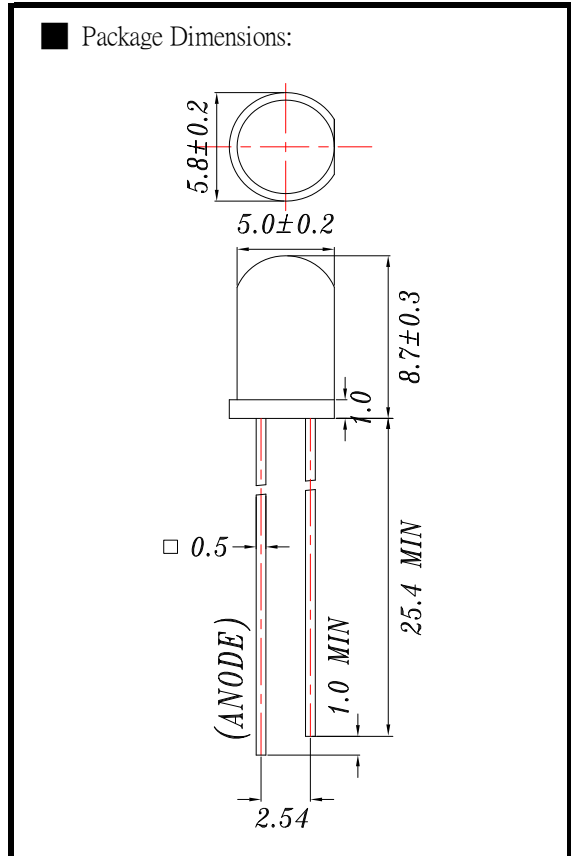

- Notes:**
1. All dimensions are in millimetres
 2. An epoxy meniscus may extend about 1.5mm(0.059") down to the lead.
 3. Tolerances unless Dimension ± 0.25 mm.

PART NO.	Chip		Lens Color
	Material	Emitted Color	
IE-5R4FA13D-9C	AlGaInP	Orange	Tinted Diffused

Absolute Maximum Ratings at Ta = 25°C

Parameter	Symbol	Rating	Unit
Forward Current	I _F	20	mA
Operating Temperature	T _{opr}	-40 to +85	°C
Storage Temperature	T _{stg}	-40 to +100	°C
Soldering Temperature	T _{sol}	260 ± 5	°C
Power Dissipation	P _d	50	mW
Peak Forward Current	I _{F(Peak)}	50	mA
Reverse Voltage	V _R	5	V

Note: *1:IFP Conditions --Pulse Width ≤ 1msec and Duty ≤ 1/10.

*2:Soldering time ≤ 5 seconds.

Electro-Optical Characteristics (Ta=25°C)

Parameter	Symbol	Condition	Min.	Typ.	Max.	Unit
Forward Voltage	V _F	I _F = 20 mA	1.9	/	2.3	V
Reverse Current	I _R	V _R = 5 V	/	/	1	μA
Luminous Intensity	I _v	I _F = 20 mA	4000	/	5000	mcd
Viewing Angle	2 θ 1/2	I _F = 20 mA	/	40	/	deg
Peak Wavelength	λ _p	I _F = 20 mA	/	622	/	nm
Dominant Wavelength	λ _d	I _F = 20 mA	612	/	617	nm
Spectrum Radiation Bandwidth	Δλ	I _F = 20 mA	/	15	/	nm

■ Typical Electro-Optical Characteristic Curves:

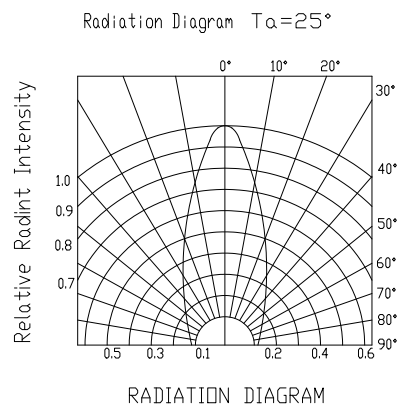
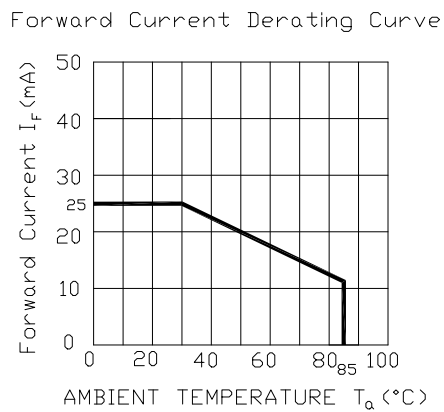
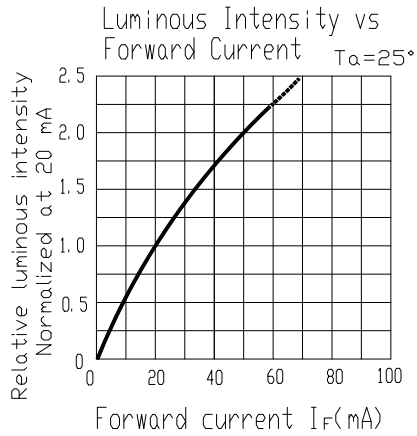
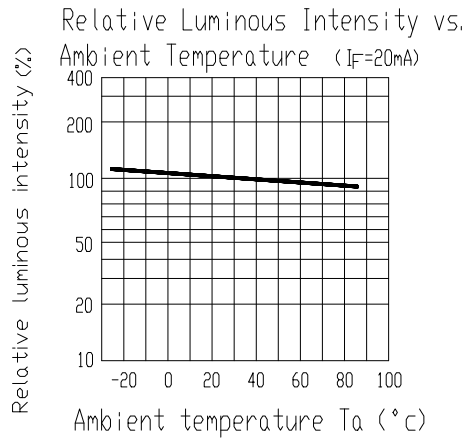
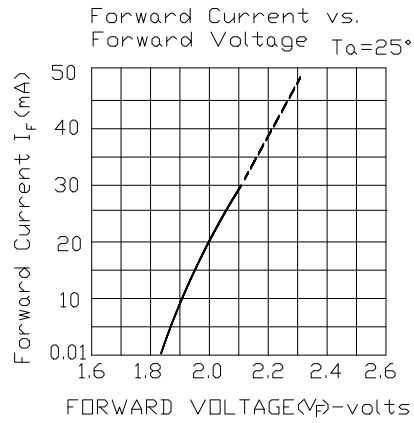
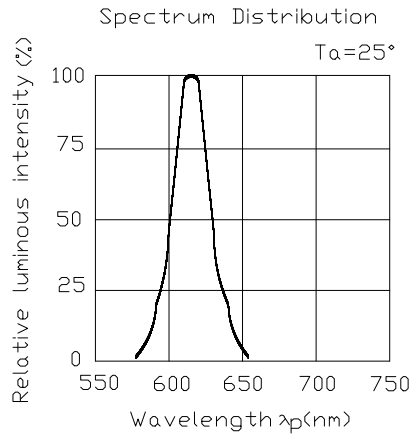

■ Reliability test items and conditions:

NO	Item	Test Conditions	Test Hours/Cycle	Sample	Ac/Re
1	Solder Heat	TEMP : 260°C ± 5 °C	10 SEC	76 PCS	0/1
2	Temperature Cycle	H : +100°C 15min ∫ 5 min L : -40°C 15min	300 CYCLES	76 PCS	0/1
3	Thermal Shock	H : +85°C 5min ∫ 10 sec L : -10°C 5min	300 CYCLES	76 PCS	0/1
4	High Temperature Storage	TEMP : 100°C	1000 HRS	76 PCS	0/1
5	Low Temperature Storage	TEMP : -40°C	1000 HRS	76 PCS	0/1
6	DC Operating Life	TEMP : 25°C If = 20mA	1000 HRS	76 PCS	0/1
7	High Temperature/ High Humidity	85°C / 85% RH	1000 HRS	76 PCS	0/1